



# HIGH TEMPERATURE DIFFERENTIAL SCANNING CALORIMETER

**DSC L62**  
*(former DSC  
PT 1600)*



---

Since 1957 LINSEIS Corporation has been delivering outstanding service, know how and leading innovative products in the field of thermal analysis and thermo physical properties.

We are driven by innovation and customer satisfaction.

Customer satisfaction, innovation, flexibility and high quality are what LINSEIS represents. Thanks to these fundamentals our company enjoys an exceptional reputation among the leading scientific and industrial organizations. LINSEIS has been offering highly innovative benchmark products for many years.

The LINSEIS business unit of thermal analysis is involved in the complete range of thermo analytical equipment for R&D as well as quality control. We support applications in sectors such as polymers, chemical industry, inorganic building materials and environmental analytics. In addition, thermo physical properties of solids and liquids can be analyzed.

LINSEIS provides technological leadership. We develop and manufacture thermo analytic and thermo physical testing equipment to the highest standards and precision. Due to our innovative drive and precision, we are a leading manufacturer of thermal Analysis equipment.

The development of thermo analytical testing machines requires significant research and a high degree of precision. LINSEIS Corp. invests in this research to the benefit of our customers.



Claus Linseis  
Managing Director

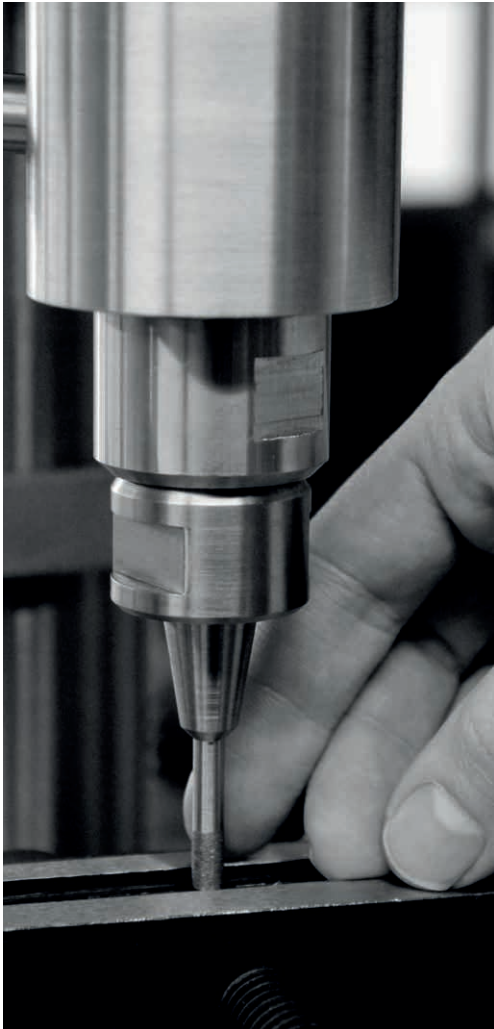

## German engineering

The strive for the best due diligence and accountability is part of our DNA. Our history is affected by German engineering and strict quality control.

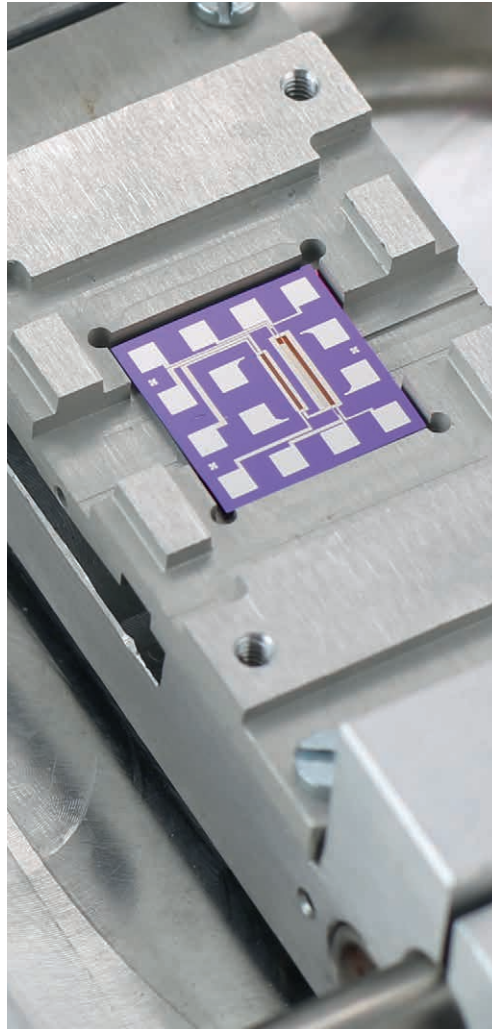

## Innovation

We want to deliver the latest and best technology for our customers. LINSEIS continues to innovate and enhance our existing thermal analyzers. Our goal is constantly develop new technologies to enable continued discovery in Science.

---

# HIGH TEMPERATURE DIFFERENTIAL SCANNING CALORIMETER

Differential Scanning Calorimetry (DSC) is the most common thermal analysis method due to its wide range of information provided. The LINSEIS high temperature DSC L62 (HDSC/DTA) is designed to deliver highest calorimetric sensitivity, short time constants and a condensation free sample chamber. These features guarantee superior resolution and baseline stability over the

entire instrument lifetime. This provides an indispensable tool for material development, R&D and quality control.

The modular concept of the HDSC and DTA systems allows the use of different furnaces with a temperature range from -150°C up to 1750°C. The vacuum tight design enables quantitative enthalpy and Cp (Specific Heat) determination under the cleanest atmospheres and under vacuum of  $10^{-5}$ mbar. The systems can be upgraded with an optional sample robot and coupled to a MS or FTIR.

The LINSEIS Differential Scanning Calorimeters (DSC) operates in agreement with national and international standards such as: ASTM C 351, D 3417, D 3418, D 3895, D 4565, E 793, E 794, DIN 51004, 51007, 53765, 65467,



# DSC- True Heat Flow measurement

## Quantitative DSC-signal

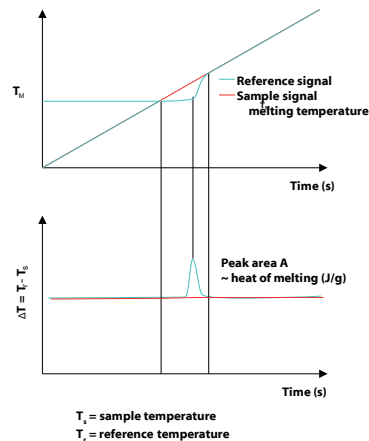
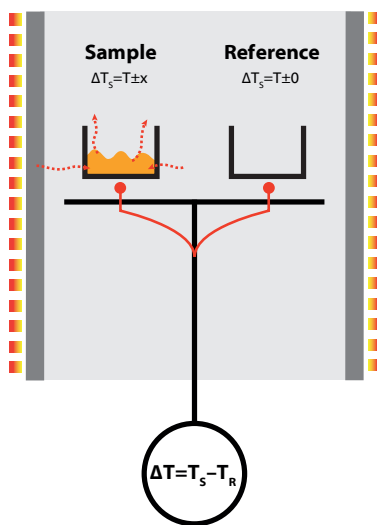

### Differential Scanning Calorimetry (DSC)

"A technique in which the difference in energy input into a substance and a reference material is measured as a function of temperature, while the substance and reference material are subjected to a controlled temperature program."

### Differential Signal

The differential signal is displayed as a baseline. Effects, for example the melting of a metal, can be observed as a peak. The area of the peak gives the amount of enthalpy and the direction of the peak indicates the way of heat flux – endothermic or exothermic.

### Temperature vs. Time

During an effect like a reaction, decomposition or phase transition, a temperature difference (heat flux difference) between the sample and the reference crucible can be measured by means of a thermocouple.

## MEASURABLE PROPERTIES

- Enthalpy
- Endo- / Exo- thermic
- Phase transformation
- Melting point
- Glass point
- Crystallinity
- Thermal stability
- Oxidation stability
- Purity
- Solidus / Liquidus relationship
- Product identification

# SENSORS

Our HDSC can be equipped with an unmatched amount of different user exchangeable DSC sensors.

Each sensor is available with different thermocouples to provide the highest sensitivity for your desired temperature range.

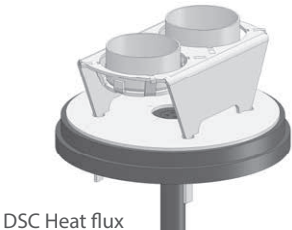

DSC Heat flux

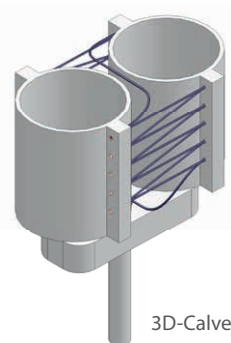

3D-Calvet-DSC sensor

DSC



0.12ml

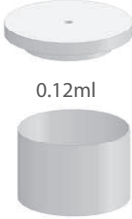

0.12ml



custom volume

Different crucibles available / broad variety

● ● ● ● ●

● ● ● ● ●

● ● ● ● ●

- Al<sub>2</sub>O<sub>3</sub>
- Platinum
- Aluminium
- others



DTA-sensor

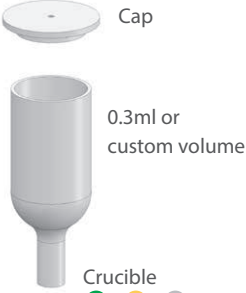

Cap

0.3ml or custom volume

Crucible

DTA

● ● ● ● ●

● ● ● ● ●

# Best possible sensitivity for your application

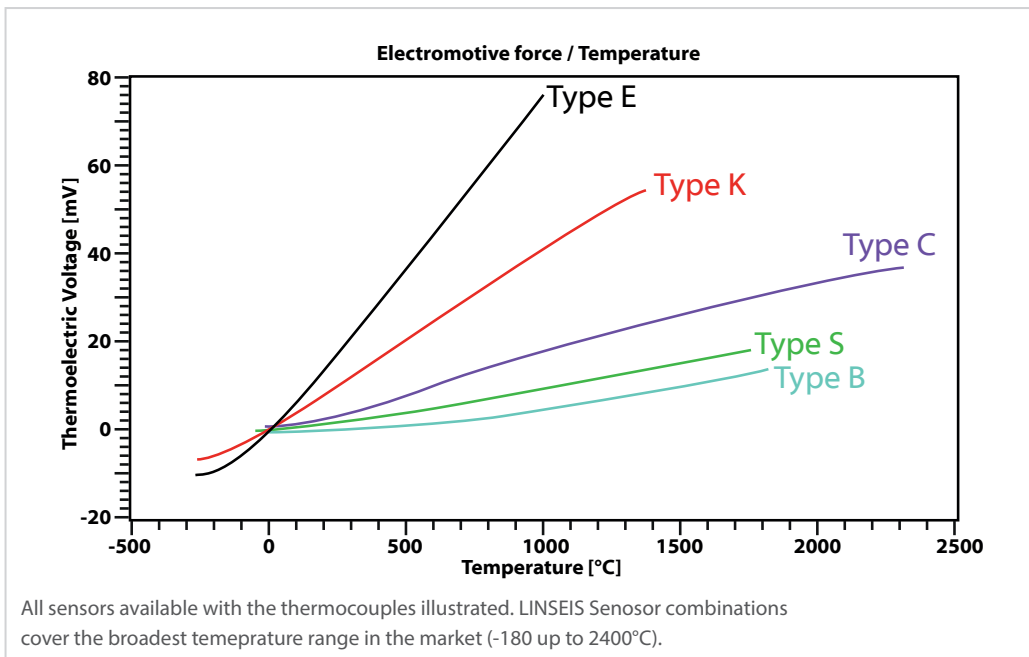

Sensor Type	(+ ) Leg	(- ) Leg	Generated EMF* change in $\mu\text{V}$ (Reference junction at 0°C)			Approx. working temperature	Notes
			At 100°C	At 500°C	T1000°C		
E	NiCr	CuNi	68	81	-	-200...800°C	Highest thermal EMF* per °C
K	Ni-Cr Cromel	Ni-Al Alumel	42	43	39	0...1100°C	Most suited for oxidizing atmosphere
S	Pt10Rh Platin-10% Rhodium	Platinum	8	9	11	0...1550°C	
B	Pt30Rh Platin-30% Rhodium	Pt6Rh Platin-6% Rhodium	1	5	9	0...1750°C	Similar as type S but higher temperature

\*Electro motive Force

# UNIQUE FEATURES

## Vacuum and controlled atmosphere

The calorimeter design provide for high vacuum, inert, reducing, oxidizing or humidified atmosphere. Furthermore, the instrument can be pressurized up to 5 bar overpressure (option). Certain corrosive conditions can be analyzed with proper precautions. The system is capable of adapting residual gas analysis systems using an optional heated capillary.

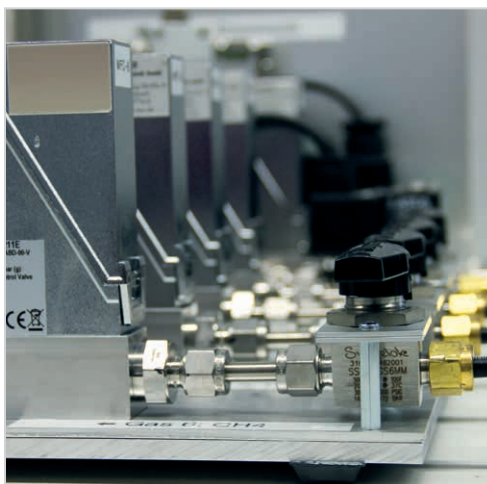

## Evolved gas analysis

Optional gas analysis with MS, FTIR or GCMS is possible. This provides valuable additional information.



## Sample robot

Our HDSC can be equipped with a proven sample robot for unattended sample measurements.

## Wide temperature range -150 to 1750°C

The LINSEIS HDSC instruments can be equipped with up to three furnaces at the same time. A broad variety of different furnaces is available to enable measurements in the widest temperature range on the market. Unmatched selection of furnaces for widest possible temperature range.





## Starter kit

The starter kit includes a variety of tool such as scissors, cutting tools, anti electrostatic tweezers, magnifier, crucible holder, pipette, rasps, spatula etc.

## Oxygen Getter Material OGM

The LINSEIS oxygen getter system (OGM) can be placed in any LINSEIS system as a modification

of the sample gas capillary. It is used to getter smallest traces of residual oxygen in the sample chamber by offering a stronger oxygen affinity than sample materials, combined with a high effective surface to ensure the oxygen molecules react with the getter before they have a chance to get in touch with the sample. Especially for oxidation sensitive samples, where hydrogen gas mixtures can't be used or very small enthalpy signals are expected, the OGM is a very effective and easy to use solution. With its modular character, it can be used for special experiments and can be easily removed for measurements under air or where the oxygen content is less important.

## Furnace Programm

Temperature	Type	Element	Atmosphere	TC-Type
-150 – -500°C	L81/264	Kanthal	inert, oxid., red., vac.	K
-150 – 1000°C	L81/264ER	Kanthal	inert, oxid., red., vac.	K
RT – 1000°C	L81/220	Kanthal	inert, oxid., red., vac.	K
RT – 1500°C	L81/230Pt	Precious Metal	inert, oxid., red., vac.	S
RT – 1600°C	L81/240	SiC	inert, oxid., red., vac.	S
RT – 1650°C	L81/240Rh	Precious Metal	inert, oxid., red., vac.	B
RT – 1750°C	L81/250	MoSi <sub>2</sub>	inert, oxid., red., vac.	B
RT – 2400°C	L81/260	Graphite	inert., red., vac.	C
<b>Special Furnaces</b>				
RT – 1100/1600°C	L81/IR/HF	IR/HF	high speed furnaces up to 100°C/s	

# CROSS SECTION OF A HDSC

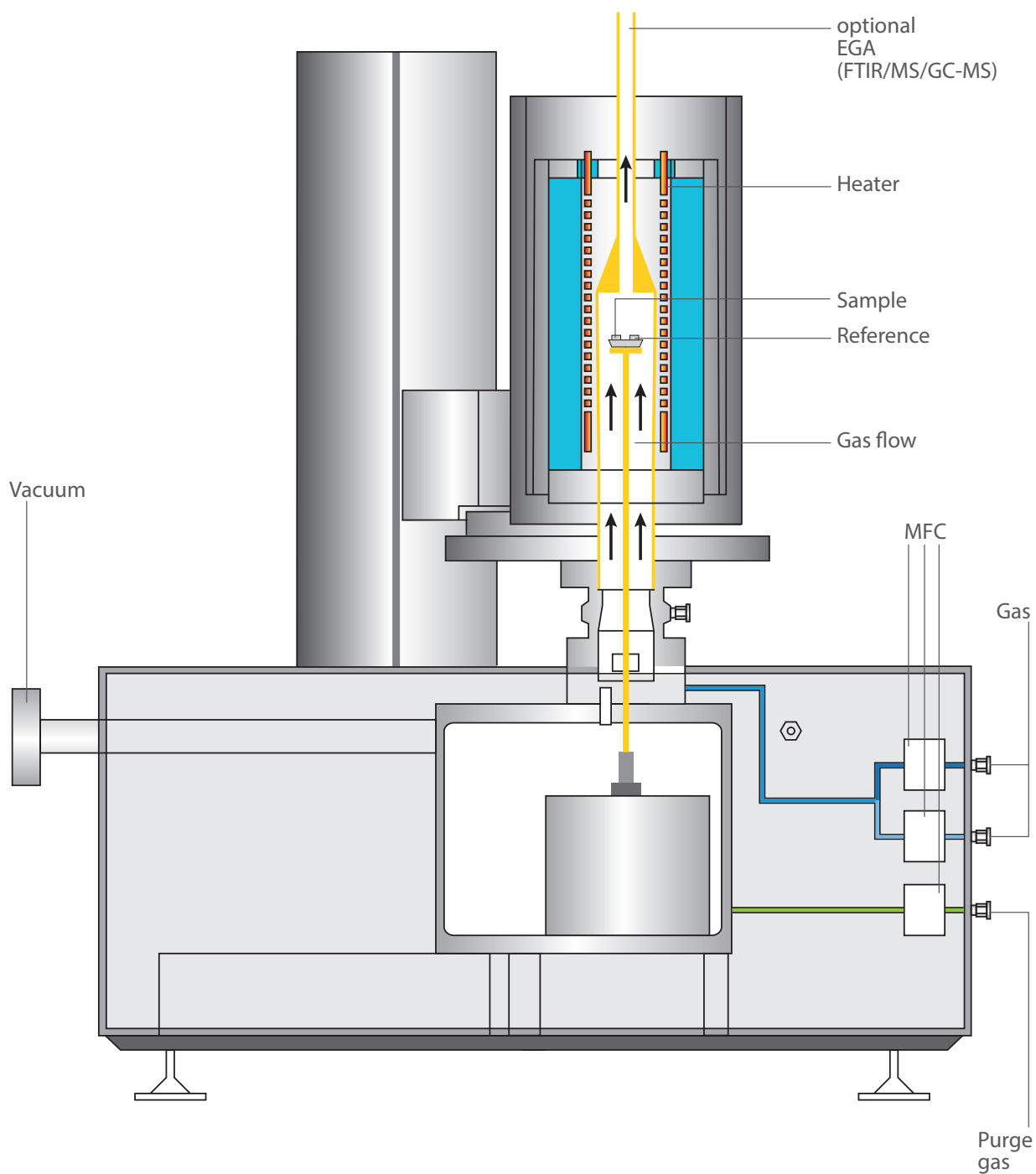

# SOFTWARE

All LINSEIS thermo analytical instruments are PC controlled. The individual software modules run exclusively under Microsoft® Windows® operating systems. The complete software consists of 3 modules: temperature control, data acquisition and data evaluation. The Windows® software incorporates all essential features for measurement preparation, execution, and evaluation of a thermoanalytical measurement. Thanks to our specialists and application experts, LINSEIS was able to develop comprehensive easy to understand user friendly application driven software.

## Features-Software:

- Program capable of text editing
- Data security in case of power failure
- Thermocouple break protection
- Repetition measurements with minimum parameter input
- Evaluation of current measurement
- Curve comparison up to 32 curves
- Storage and export of evaluations
- Export and import of data ASCII
- Data export to MS Excel
- Multi-methods analysis (DSC TG, TMA, DIL, etc.)
- Zoom function
- 1 and 2 derivation
- Programmable gas control
- Curve arithmetics
- Statistical evaluation package
- Free scaling

- Optional Kinetic and Lifetime Prediction Software packages

## HDSC – Features:

- Glass transition temperature
- Complex peak evaluation
- Multipoint calibration for sample temperature
- Multipoint calibration for change of enthalpy
- Cp calibration for heat flow
- Signal-steered measuring procedures

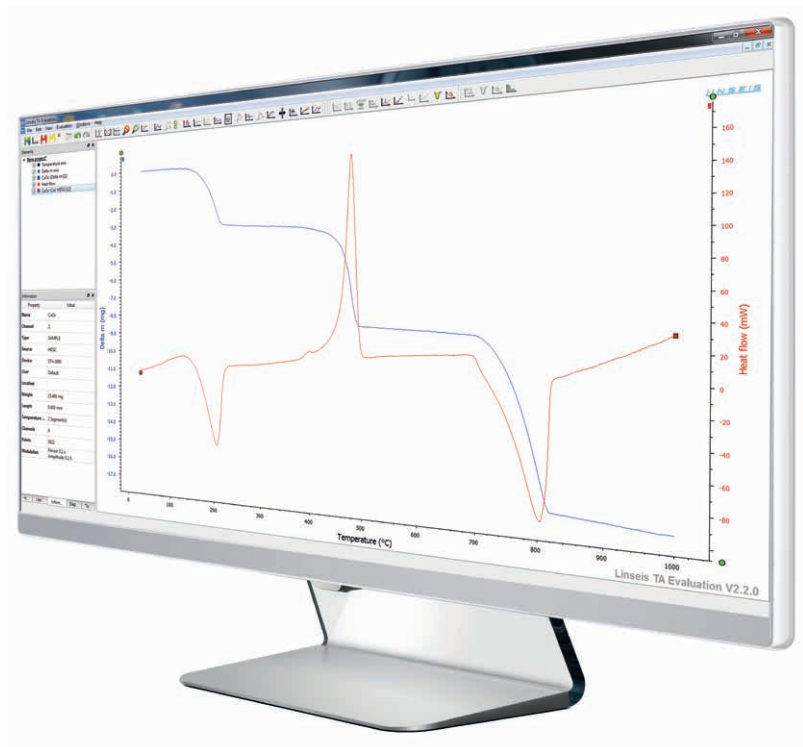

## Thermal Library

The LINSEIS Thermal Library software package comes as an option for the well-known, user friendly LINSEIS Platinum evaluation software that is integrated in almost all our instruments.

The Thermal Library allows you the comparison of the complete curves with a data base providing thousands of references and standard materials within only 1-2 seconds.

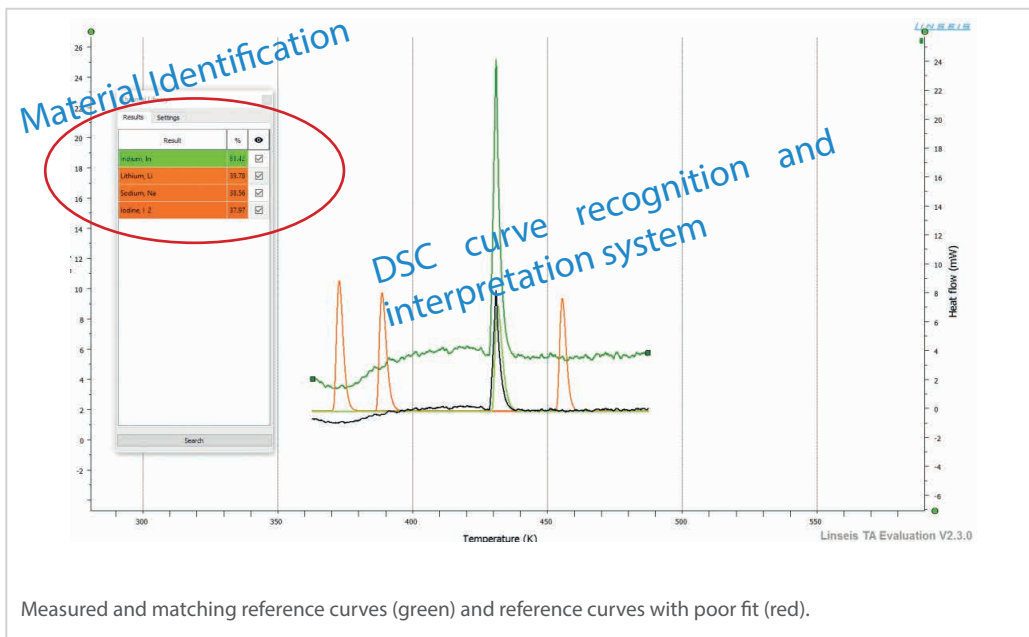

## Multi-Instrument

All LINSEIS instruments DSC, DIL, STA, HFM, LFA, etc. can be controlled from one software template.

## Report Generator

Convenient template selection to generate customized measurement reports.

## Data Base

State of the art data base design enables easy data handling.

## Multi-Lingual

Our software is available in many different user exchangeable languages, such as: English, Spanish, French, German, Chinese, Korean, Japanese, etc.

## Multi-User

The administrator can generate different user levels providing different rights to operate the instrument. An optional Log file is available, too.

## Kinetic software

Kinetic analysis of DSC, DTA, TGA, EGA (TG-MS, TG-FTIR) data for the study of the thermal behavior of raw materials and products.

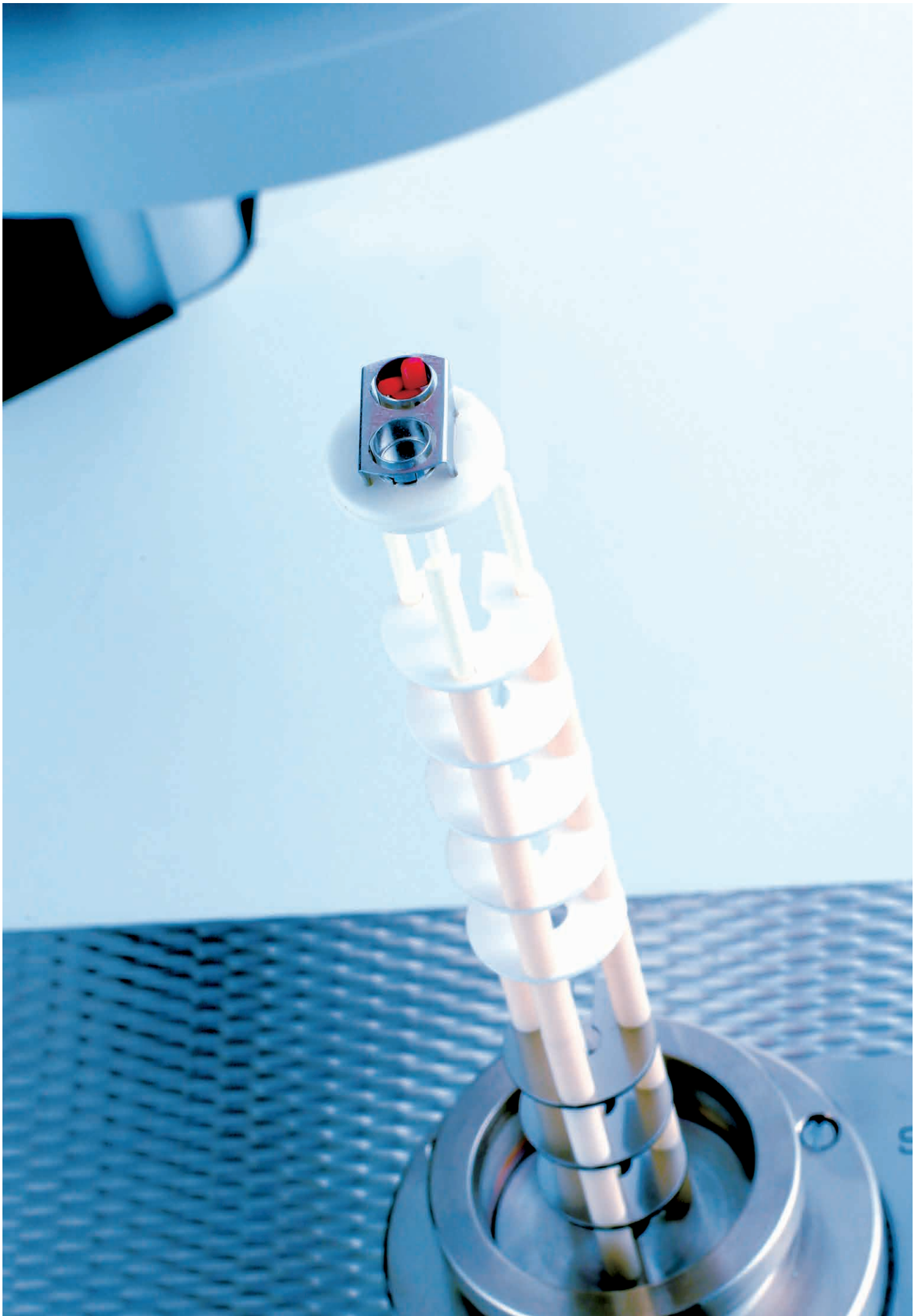

# SPECIFICATIONS

DSC L62 (HDSC PT 1600)	
Temperature range	-150 up to 700°C RT up to 1600 / 1750°C
Vacuum	10 <sup>-5</sup> mbar (depends on vacuum pump)
Pressure	up to 5 bar (optional)
Heating rate	0.001 up to 50 K/min (depends on furnace)
Temperature precision	0.01°C
Sample robot	optional 42
DSC	
DSC-sensors	E / K / S / B / C
DSC resolution	0.3 / 0.4 / 1 / 1.2 μW
Calorimetric sensitivity	approx. 4 / 6 / 17.6 / 22.5 μW
DTA	
DTA-resolution	0.05 μV
Sensitivity	1.5 μV/mW
DTA-measuring ranges	250 / 2500 μV

# APPLICATIONS

## Steel (Low-Alloyed Steel)

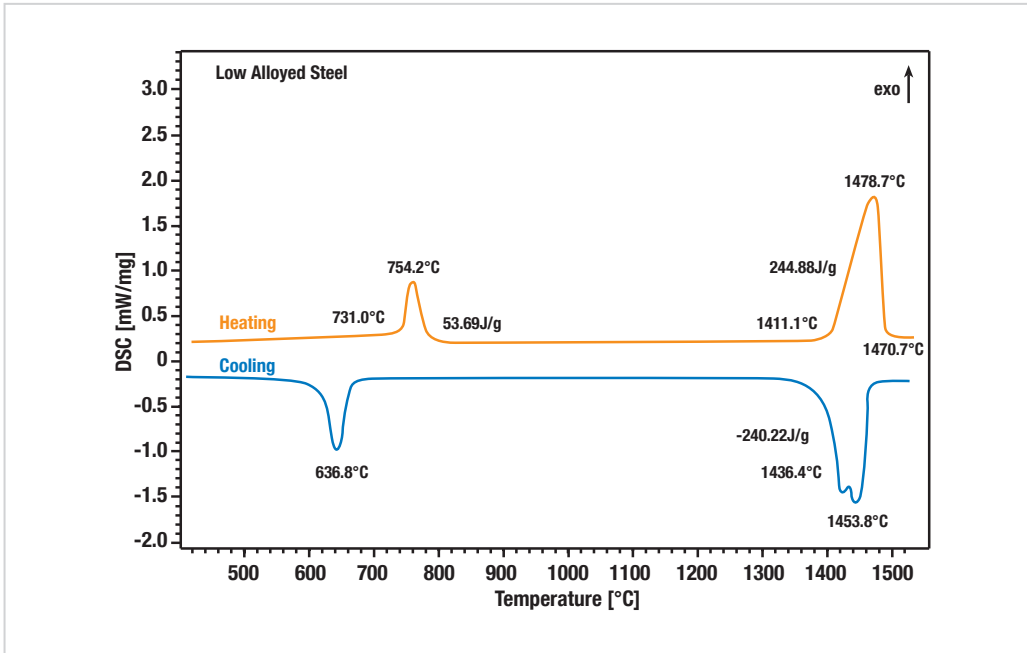

The picture shows the specific heat flow rate of a low-alloyed steel sample, measured by HDSC. At 734°C the change in the crystal structure (from body center to face center) and the change in the magnetic properties (ferromagnetic to paramagnetic) occurred. The melting point can be seen at 1411°C. The liquidus temperature was measured at 1473°C. All peaks are reversible and can be observed in the cooling segment as well. The phase transition to ferromagnetic takes place at 637°C and the crystallization range goes from 1454°C to 1436°C.

## DSC powder measurements of ferrites

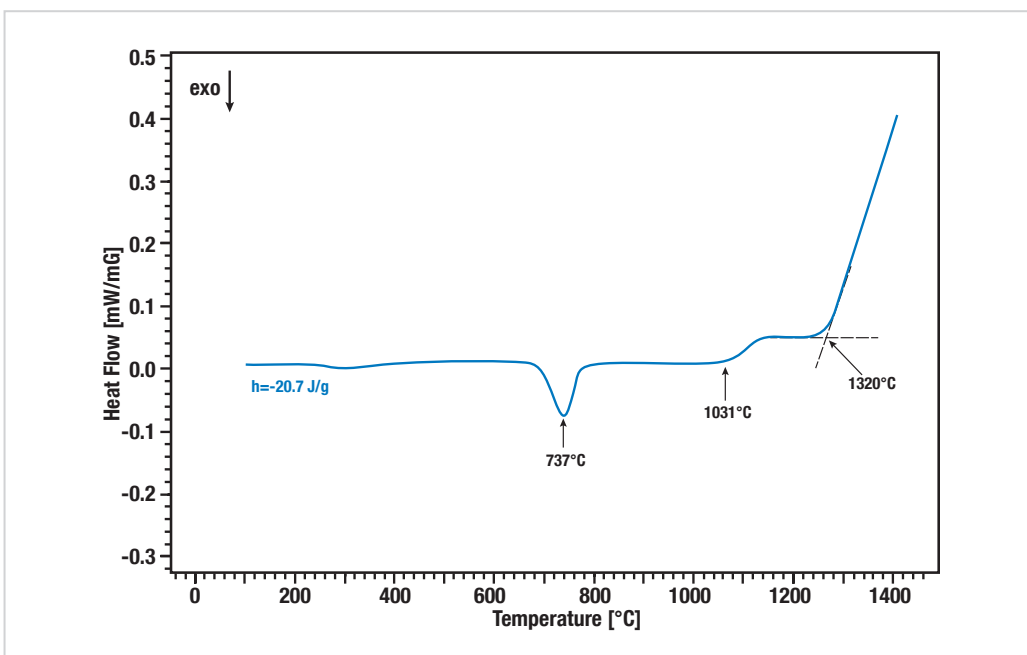

The components used for production of magnetic ferrites are ZnO, Fe<sub>2</sub>O<sub>3</sub> and Cr<sub>2</sub>O<sub>3</sub>. The Chrome oxide is added for modification of magnetic and electric properties. At 735°C the powder forms a mixed ferrite with a spinel structure (exothermal reaction: -20.6 J/g). Above 1034°C and 1321°C the heat flow changes into the endothermic direction due to melting of different phases. The LINSEIS DSC L62 with type S measuring sensor provides a very stable baseline with an extremely low noise level up to 1600°C. This high sensitivity is essential to perform exact reaction enthalpy measurements and evaluations.

## DSC Analysis of Talcum

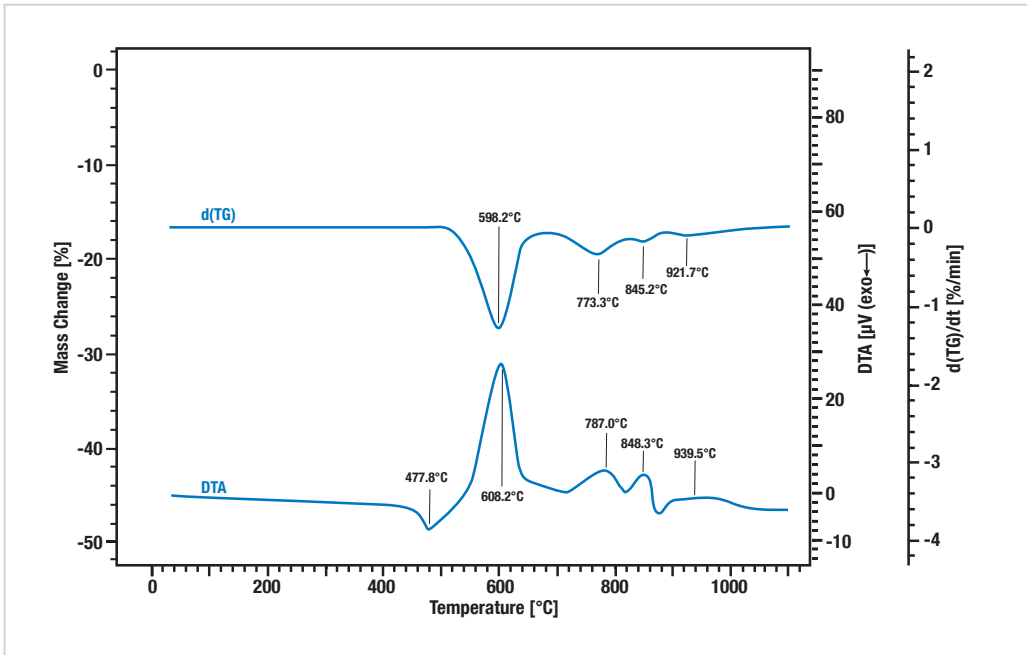

Talcum ( $Mg_3(OH)_2[Si_2O_5]_2$ ) is a mineral that consists of hydrated magnesium silicate. It is used for the production of stearate bodies used as isolators with high resistance and a low dielectric loss factor. Its impurities (chlorite, carbonates) can be determined and detected using DSC.

The measurement shows the dehydroxylation of chlorite that appears at 608°C and 848°C as endothermal DSC signals. At 768°C the removal of  $CO_2$  can be observed when the contained carbonates decompose into their oxides, releasing the  $CO_2$ . Finally the dehydroxylation of talc can be seen at 937°C as an endothermal peak as well.

## Modulated Cp determination

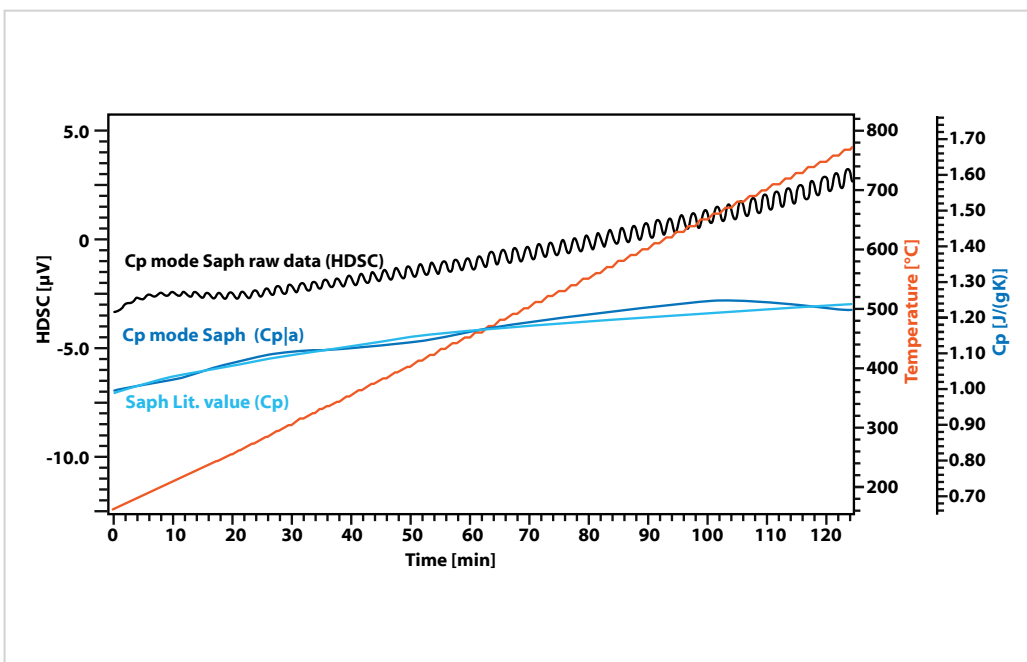

For highest possible accuracy of Cp, the LINSEIS DSC allows the usage of modulated heating rate temperature profiles. This method causes a continuous change in heat flow of the sample and the system can monitor the heat uptake much better than with a linear heating profile. The deviation from the literature value is much smaller than with linear DSC runs.

The modulated heat flow signal (black) leads to a significant better Cp resolution (dark blue) that is only slightly different from the literature (bright blue) over the full temperature range. The orange curve shows the modulated heating profile.



LINSEIS GmbH Germany

Vielitzerstr. 43

95100 Selb

Tel.: (+49) 9287 880 0

E-mail: [info@linseis.de](mailto:info@linseis.de)



LINSEIS Inc. USA

109 North Gold Drive

Robbinsville, NJ 08691

Tel.: (+1) 609 223 2070

E-mail: [info@linseis.de](mailto:info@linseis.de)



LINSEIS China

Kaige Scientific Park 2653 Hunan Road

201315 Shanghai

Tel.: (+86) 61 90 12 03

Tel.: (+86) 50 55 06 42

E-mail: [info@linseis.com.cn](mailto:info@linseis.com.cn)



Linseis Thermal Analysis India Pvt. Ltd.

Plot 65, 2nd floor, Sai Enclave, Sector 23

Dwarka

110077 New Delhi

Tel.: +91 11 42883851

E-mail: [sales@linseis.in](mailto:sales@linseis.in)

**RMI, s.r.o.**

Pernštýnská 116

533 41 Lázně Bohdaneč

Tel: 466 921 885, 404

e-mail: [sale@rmi.cz](mailto:sale@rmi.cz)

web: [www.rmi.cz](http://www.rmi.cz)

[www.linseis.com](http://www.linseis.com)

Products: DIL, TG, STA, DSC, HDSC, DTA, TMA, MS/FTIR, In-Situ EGA, Laser Flash, Seebeck Effect, Thin Film Analyzer, Hall-Effect

Services: Service Lab, Calibration Service

03/25

**LINSEIS**