

**LINSEIS**

T H E R M A L   A N A L Y S I S

# SIMULTANEOUS THERMAL ANALYSIS

STA HP L84

*(former STA HP 1/2)*



---

Since 1957 LINSEIS Corporation has been delivering outstanding service, know how and leading innovative products in the field of thermal analysis and thermo physical properties.

Customer satisfaction, innovation, flexibility and high quality are what LINSEIS represents. Thanks to these fundamentals our company enjoys an exceptional reputation among the leading scientific and industrial organizations. LINSEIS has been offering highly innovative benchmark products for many years.

The LINSEIS business unit of thermal analysis is involved in the complete range of thermo analytical equipment for R&D as well as quality control. We support applications in sectors such as polymers, chemical industry, inorganic building materials and environmental analytics. In addition, thermo physical properties of solids, liquids and melts can be analyzed.

LINSEIS provides technological leadership. We develop and manufacture thermo analytic and thermo physical testing equipment to the highest standards and precision. Due to our innovative drive and precision, we are a leading manufacturer of thermal Analysis equipment.

The development of thermo analytical testing machines requires significant research and a high degree of precision. LINSEIS Corp. invests in this research to the benefit of our customers.



Claus Linseis  
Managing Director

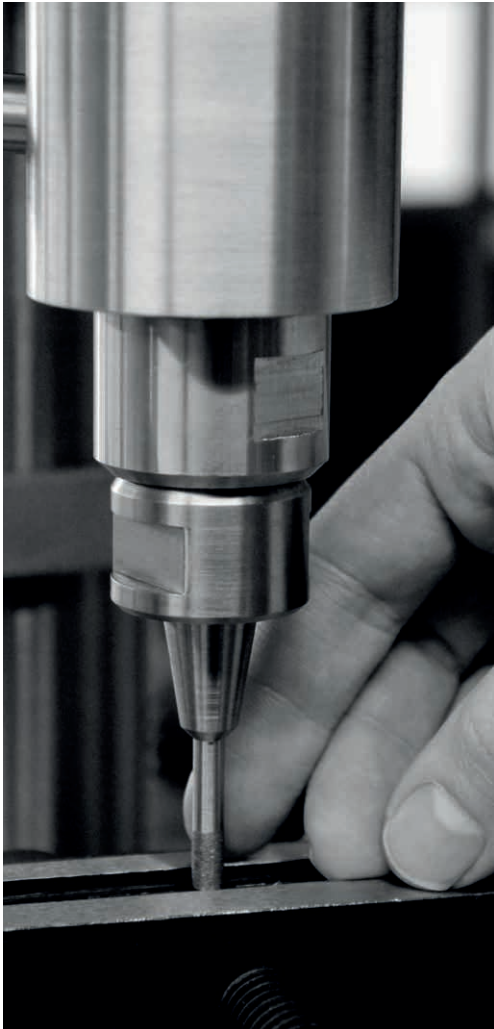

## German engineering

The strive for the best due diligence and accountability is part of our DNA. Our history is affected by German engineering and strict quality control.

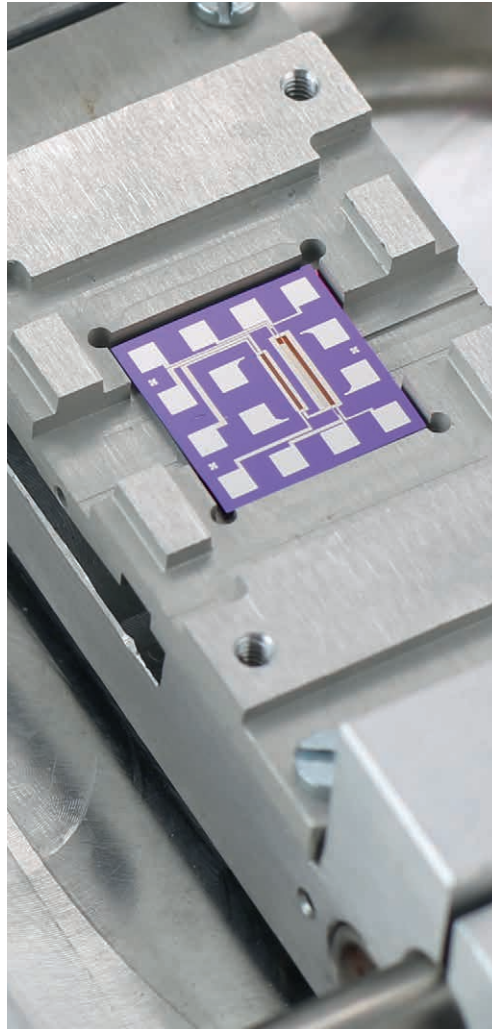

## Innovation

We want to deliver the latest and best technology for our customers. LINSEIS continues to innovate and enhance our existing thermal analyzers. Our goal is constantly develop new technologies to enable continued discovery in Science.

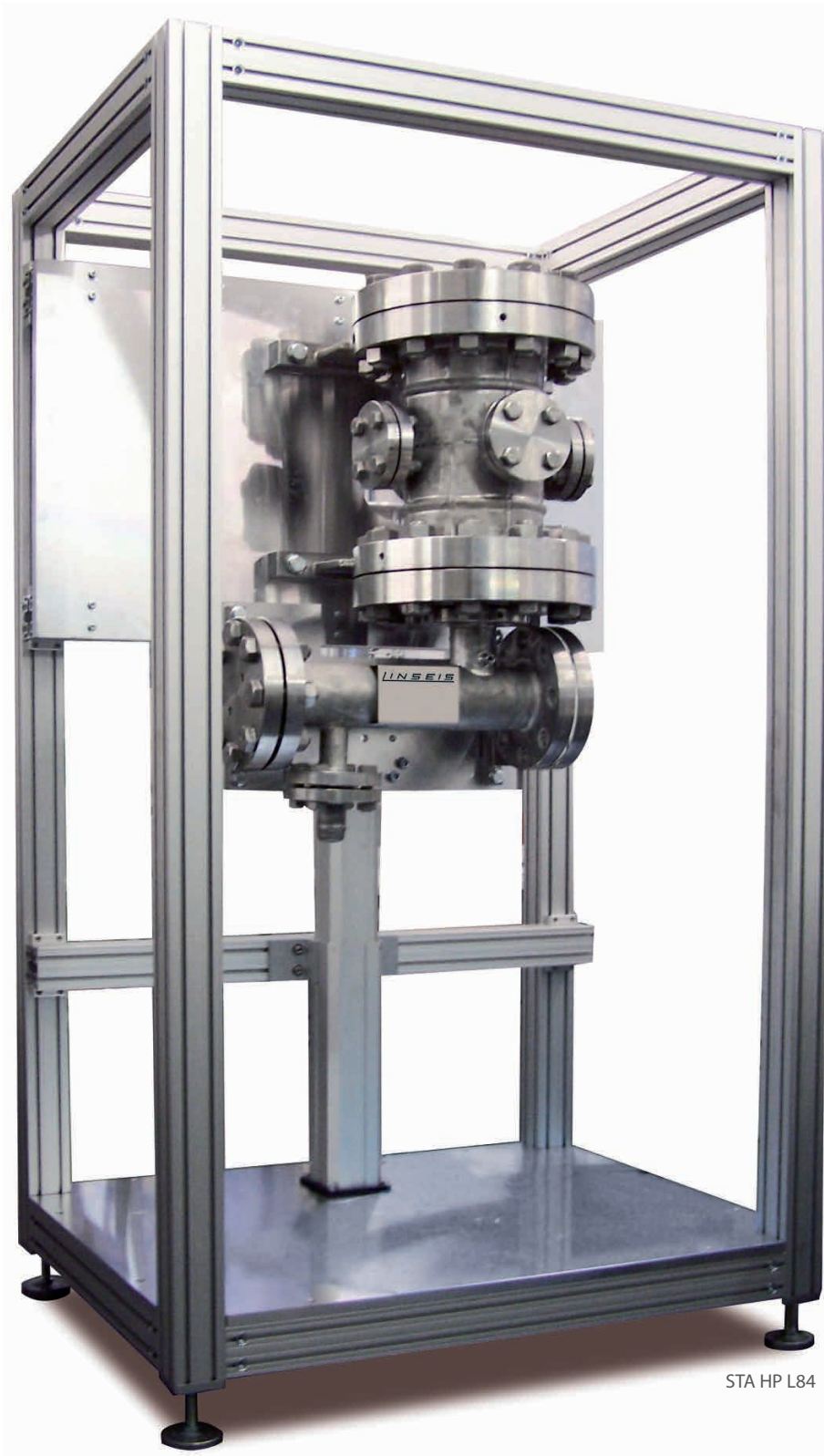

STA HP L84

---

# THE INSTRUMENT

Thermogravimetry is a technique in which the mass of the sample is monitored against time or temperature while the temperature of the sample, in a specified atmosphere, is programmed. This technique serves the determination of material compositions.

Simultaneous TGA-DTA/DSC measures both heat flow (DSC) and weight changes (TGA) in a material as a function of temperature or time in a controlled atmosphere. Simultaneous measurement of these two material properties not only improves productivity but also simplifies interpretation of the results. The complementary information obtained allows differentiation between endothermic and exothermic events which have no associated weight loss (e.g., melting and crystallization) and those which involve a weight loss (e.g., degradation).

The High Pressure LINSEIS STA (simultaneous thermal analysis) delivers unsurpassed performance. The system can be used to determine simultaneous changes of mass (TG) and caloric reactions (HDSC) under defined atmosphere and pressure (up to 150 bar) in the temperature range RT...1800°C. This instrument is worldwide the only available pressure STA.

The unique characteristics of this product are high precision, high resolution and long term drift stability. The STA Platinum Series was especially developed to meet the challenging de-

mands of the high temperature as well as high pressure applications.

From the combination of TG and DTA or DSC one receives a broad range of information, such as:

TG:

- Mass change
- Absolute sample temperature
- Temperature difference (sample / reference)

HDSC:

- Enthalpy, melting energy
- Specific heat
- Glass point
- Crystallinity
- Reaction enthalpy
- Thermal stability
- Oxidation stability
- Aging
- Purity
- Phase transformation
- Solidus / liquidus - relationship
- Eutecticum
- Polymorphism
- Product identification

Main Application of the STA HP:

- Pyrolysis studies
- Gasification of coal and biomass
- CO<sub>2</sub> sequestration
- Testing of getter materials (O<sub>2</sub>, H<sub>2</sub>, etc.)
- Metal reduction/oxidation studies

---

# SOFTWARE

All LINSEIS thermo analytical instruments are PC controlled. The individual software modules exclusively run under Microsoft® Windows® operating systems. The complete software consists of 2 modules: data acquisition and data evaluation.

The 32 bit software incorporates all essential features for measurement preparation, execution, and evaluation of a Thermogravimetric measurement. Thanks to our specialists and application experts, LINSEIS was able to develop comprehensive easy to understand user friendly application software.

Features -Software:

- Data security in case of power failure
- Repetition measurements with minimum parameter input



- Evaluation of current measurement
- Curve comparison up to 32 curves
- Storage and export of evaluations
- Export and import of data ASCII
- Data export to MS Excel
- Report generator
- Database structure
- Redo and Undo function
- Multi-methods analysis (DSC TG, TMA, DIL, etc.)
- Zoom function
- 1 and 2 derivation
- Programmable gas control
- Statistical evaluation package
- Free scaling
- Program capable of text editing
- Thermocouple break protection

TG – Features:

- Mass change as % and mg
- Evaluation of mass loss
- Residue mass evaluation

HDSC – Features:

- Glass transition temperature
- Curve subtraction
- Complex peak evaluation
- Multipoint calibration for sample temperature
- Multipoint calibration for change of enthalpy
- Cp calibration for heat flow

# UNIQUE FEATURES

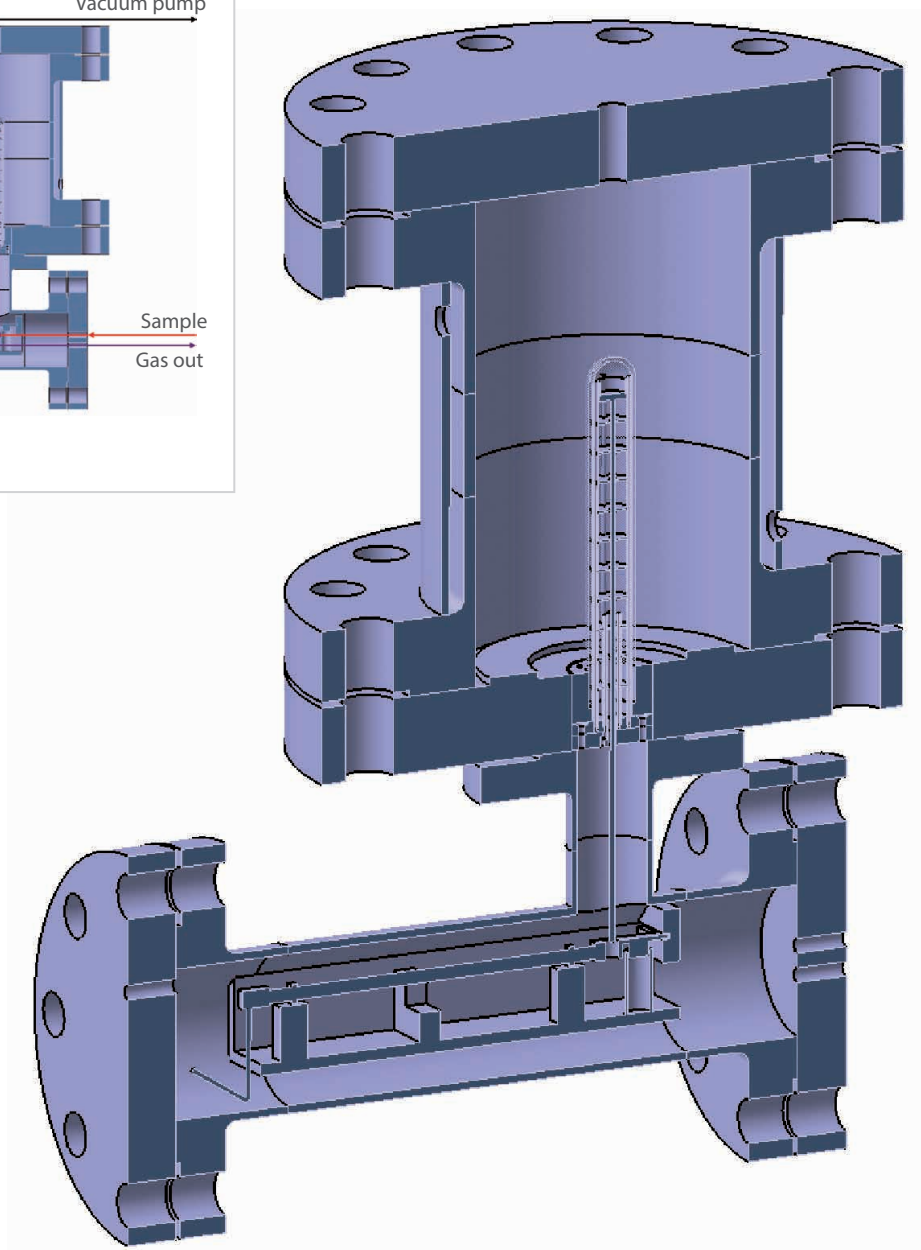
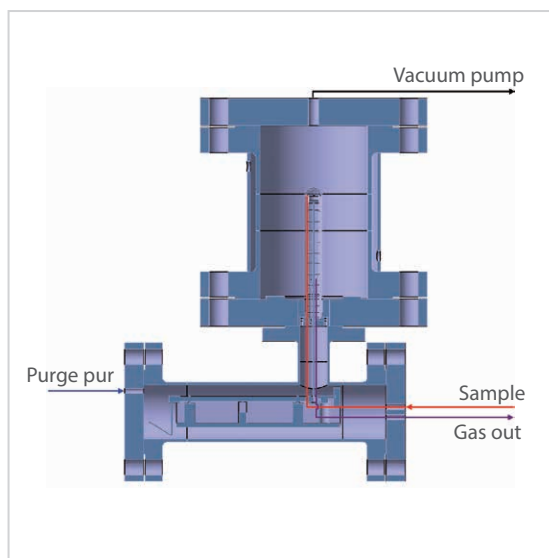

---

# SPECIFICATIONS

	STA HP L84 (former STA HP 1)	STA HP L84 (former STA HP 2)
Temperature range	RT up to 1100°C	RT up to 1400°C/1800°C
Heating element	Kanthal	SiC or graphite
Pressure range	up to 150 bar	up to 50 bar
Vacuum	up to 10 <sup>-4</sup> mbar	up to 10 <sup>-4</sup> mbar
TG resolution	0.1 / 0.5 / 10 µg	0.1 / 0.5µg
Sample weight	2 / 15 / 100g	2 / 15g
TG-DTA/DSC measuring systems	E/K/S/C	E/K/S/B/C
Atmosphere	inert, oxid., red., vac.	inert, oxid*, red., vac.

*\* Not possible with graphite heater*

# APPLICATIONS

## Coal gasification under CO<sub>2</sub>

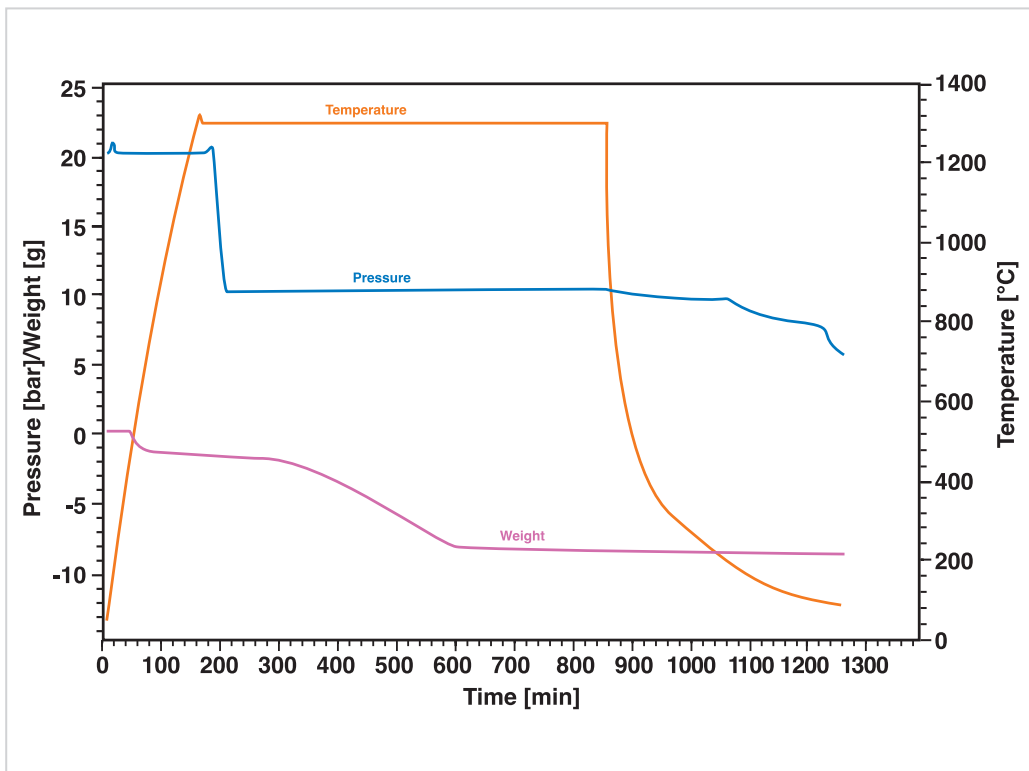

Example of coal sample being gasified under CO<sub>2</sub> atmosphere

Experimental conditions:

- 20 bar N<sub>2</sub> during heating,
- 10 bar CO<sub>2</sub> during gasification

## Charcoal gasification under carbon dioxide

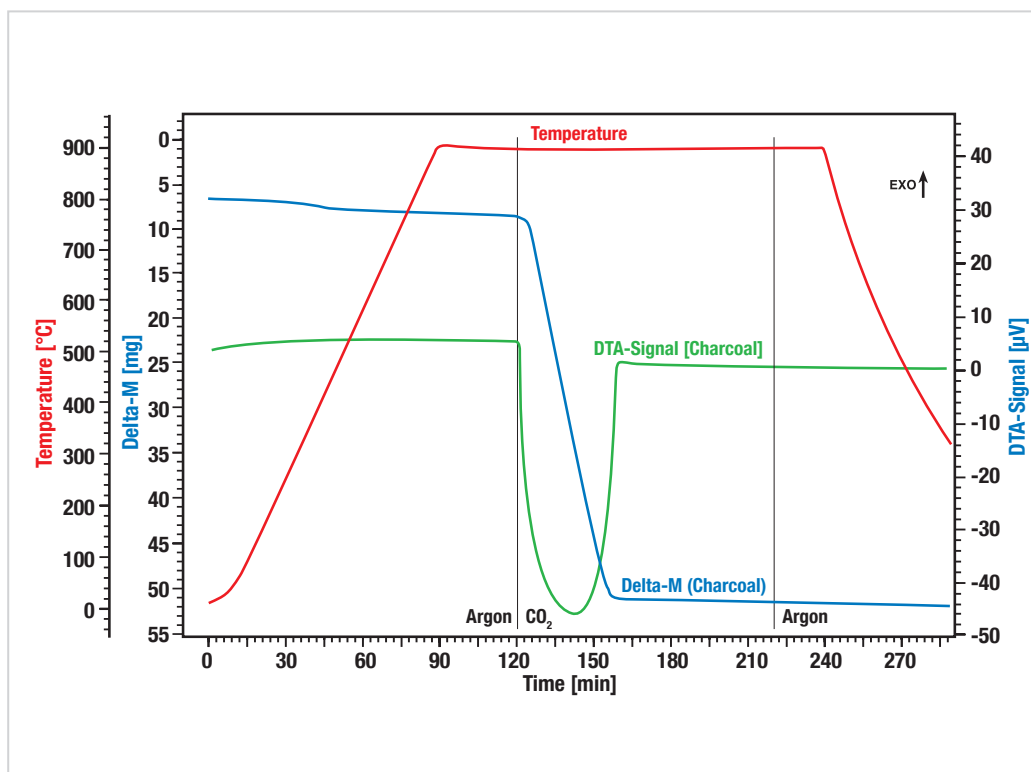

This application shows a typical measurement of a Charcoal gasification under Carbon Dioxide atmosphere at a pressure of 20 bar.

## Calcium oxalate under different conditions

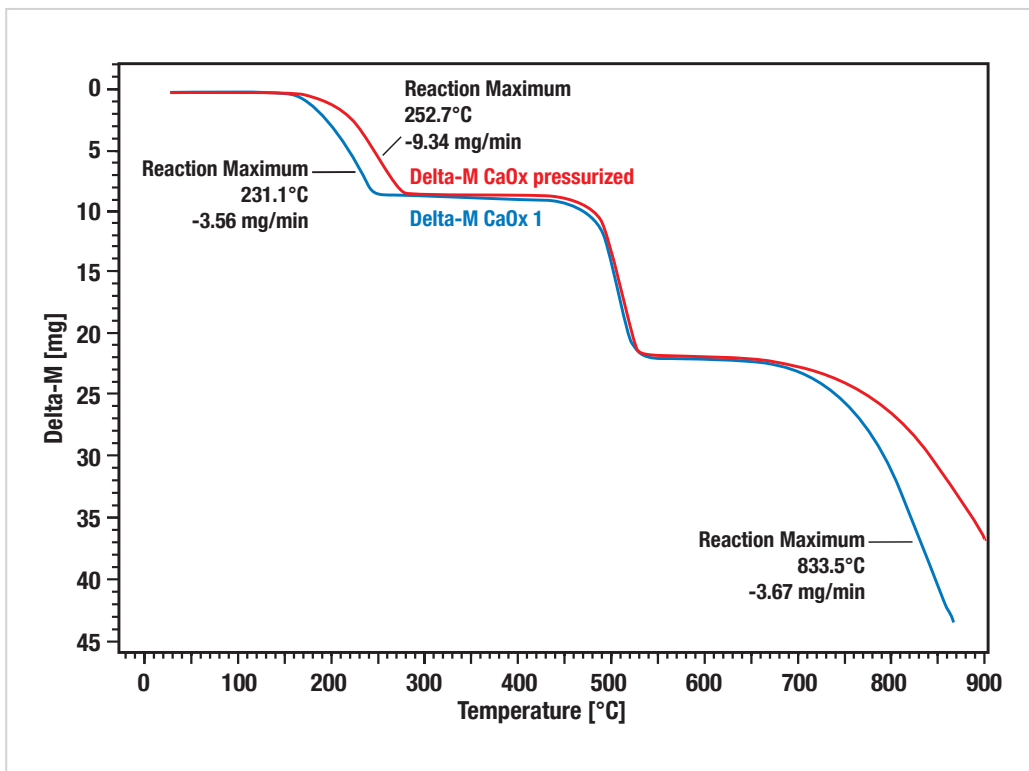

Comparison of Calcium Oxalate decomposition under Pressure (20 bar, red curve) vs. atmospheric condition (blue curve). A significant pressure dependence of the decomposition steps 1 and

3 can be observed. The decomposition steps 1 and 3 are shifted to higher temperatures at elevated pressure.



LINSEIS GmbH Germany

Vielitzerstr. 43

95100 Selb

Tel.: (+49) 9287-880 - 0

Fax: (+49) 9287-70488

E-mail: [info@linseis.de](mailto:info@linseis.de)



LINSEIS Inc. USA

109 North Gold Drive

Robbinsville, NJ 08691

Tel.: (+1) 609 223 2070

Fax: (+1) 609 223 2074

E-mail: [info@linseis.com](mailto:info@linseis.com)



LINSEIS China

Kaige Scientific Park 2653 Hunan Road

201315 Shanghai

Tel.: (+21) 5055 0642

Fax.: (+21) 6806 3576



Linseis Thermal Analysis India

Pvt. Ltd.

Plot 65, 2nd Floor, Sai Enclave,

Sector 23, Dwarka, 110077

New Delhi

Tel.: +91-11-42883851

E-mail: [sales@linseis.in](mailto:sales@linseis.in)

**RMI, s.r.o.**

Pernštýnská 116  
533 41 Lázně Bohdaneč  
Tel: 466 921 885, 404  
e-mail: [sale@rmi.cz](mailto:sale@rmi.cz)  
web: [www.rmi.cz](http://www.rmi.cz)

[www.linseis.com](http://www.linseis.com)

Products: DIL, TG, STA, DSC, HDSC, DTA, TMA, MS/FTIR, In-Situ EGA, Laser Flash, Seebeck Effect, Thin Film Analyzer, Hall-Effect

Services: Service Lab, Calibration Service

03/25

**LINSEIS**