



Bringing Raman to Life

Wasatch) Photonics

# Raman from research to reality



Raman spectroscopy began as an experiment into the scattering of light, but C.V. Raman and K.S. Krishnan saw something more. They saw molecules with a voice – molecules waiting to be heard.

With sun as source and photographic plate as detector, it is incredible that they saw Raman scattering at all. But that's how science works. You get an idea, a whisper of a possibility, and you find the tools to make it real. At Wasatch Photonics, we make those tools. Tools uniquely crafted to the needs of Raman researchers and OEMs; tools with the sensitivity, signal to noise ratio (SNR), speed, and usability to enable the next generation of Raman applications and solutions.

Raman has finally come into its own this century through a convergence of technology and greater understanding of how it can be applied to problems spanning every area of science, industry, security & health. Once a laboratory technique, it is now a viable solution for the factory, the field, and the clinic. As you explore its possibilities, we're ready to hear you, and find ways together to make them real.

*"We've made it our mission to close the gap between compact and benchtop spectroscopy system performance for the solution of real world applications, and that's how we're bringing Raman to life."*

*- Dr. David Creasey, CEO*



# Why Wasatch for Raman solutions

In the growing world of Raman spectroscopy, what makes one company different than the rest? At [Wasatch Photonics](#), we offer a unique combination of vision, talent, and technology that help bridge the gap between research and reality for those seeking solutions to the most pressing problems facing our world.

Independently owned & innovation-minded, we have the freedom to pursue the projects with the potential to do the most good, and the passion and determination to see them through. We are constantly building toward the future, with [expanded capacity](#), new talent, and better processes to sustain our momentum. And through it all, we are keeping our eye on what is important to you:

1

## Performance

What would you do with more speed, sensitivity, or lower limit of detection? With [10x more signal](#) than traditional compact spectrometers, we excel at many measurements commonly associated with high-end benchtop Raman analyzers or microscope-based systems.

2

## Applications Knowledge

Our team brings a [wealth of experience](#) in tackling problems with spectroscopy, and an intimate understanding of our product performance and possibilities, allowing us to connect product and purpose with elegant, cost-effective solutions.

3

## Product Focus

We've designed our spectrometers and software specifically for the needs of Raman, optimizing for SNR, stability, and reliability. Our ['OEM by design'](#) approach allows you to transition easily from proof-of-concept to integrated instrument without compromise.

4

## Flexibility & Creativity

We offer [modular](#) and [integrated systems](#) at more wavelengths than anywhere else, allowing you to fine-tune parameters like range, resolution, and noise. Our best products have come out of your needs - if we don't have it, we can create it.



# Performance that transcends the lab

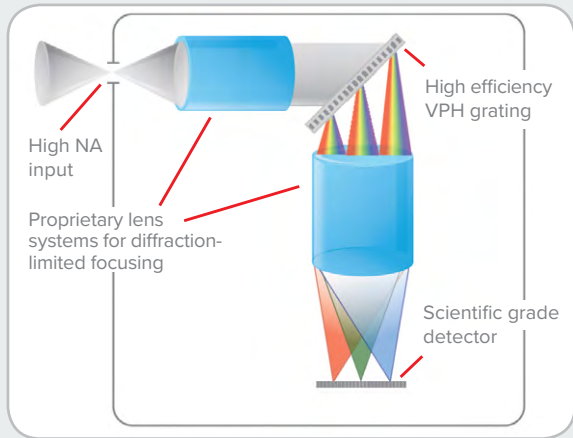

## SUPERIOR OPTICAL DESIGN

Our [spectrometer design](#) is specific to the needs of Raman - high sensitivity, low noise, and able to capture spectra quickly. It's a compact, transmissive design based on our own gratings that preserves symmetry, reduces aberrations, and minimizes image plane curvature. Diffraction-limited focusing across all detector pixels optimizes spectral resolution, detection efficiency, and unit to unit repeatability. We also use an extremely high  $f/1.3$  collection aperture vs the typical limited  $f/4$ . This allows us to collect much more light, because in Raman spectroscopy, every photon is precious.

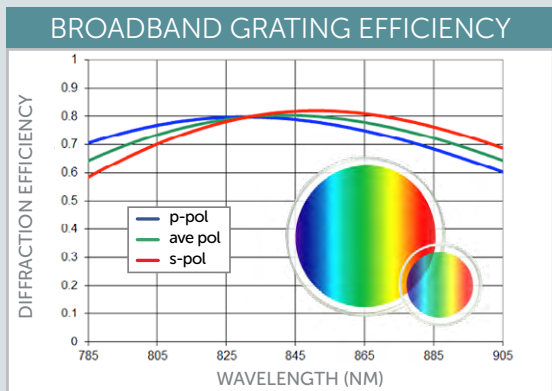

## PATENTED VPH GRATINGS

Although reflective, ruled gratings have long been the standard in spectroscopy, volume phase holographic (VPH) gratings offer [many key advantages](#): 40% higher efficiency, smoother response curves, less polarization sensitivity, very little scatter or ghosting, and excellent repeatability in volume. And we make our own. In fact, we hold the patent on broadband 'HD' VPH gratings - a grating perfect for Raman, from one end of the spectrum to the other. We match the perfect VPH grating to each of our optical designs, and can create bespoke gratings to give our OEMs a unique edge.

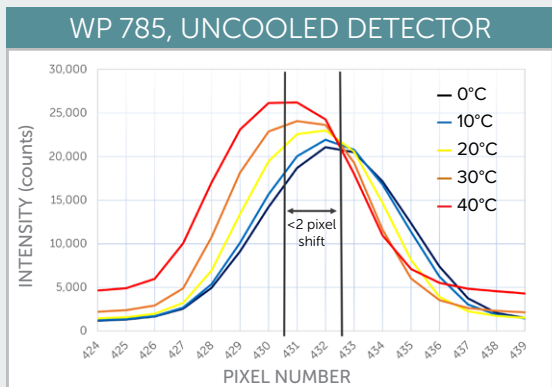

## ROBUST OPTO-MECHANICS

A good design is a robust design, insensitive to the temperature drift, shock, and vibration that most diagnostic devices see daily. By taking the time to craft our opto-mechanical assemblies with volume use in mind, we've dramatically reduced the variability associated with compact spectrometers. Diffraction-limited focusing across the detector array makes our design [highly tolerant to thermal shifts](#), and eliminates impact on peak symmetry. This is key in Raman, as spectrometers must perform reliably across a wide range of environmental conditions to avoid recalibration or compensation.

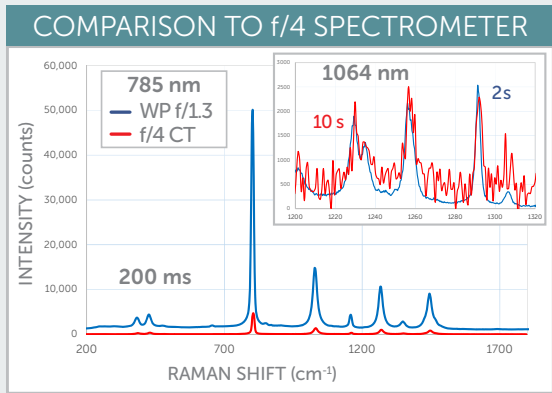

## HIGHER SENSITIVITY & SPEED

In a signal-limited technique like Raman, more photons mean more freedom and new possibilities. Our optical design yields [>10x more signal](#) than an f/4 Czerny Turner (CT) spectrometer, which translates directly into sensitivity and speed. We provide dramatically higher signal at the same measurement time, allowing you to see clearer peaks, smaller signals, and test out new applications. Even when measuring at 1064 nm, we deliver far better signal to noise, giving you better quality data in less time for your most challenging measurements - in the lab, in the field, at the clinic, or online.

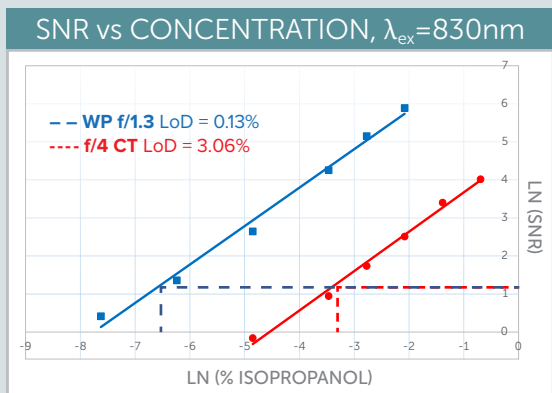

## LOWER LIMIT OF DETECTION

It makes sense that more signal and less noise would result in higher SNR and lower limit of detection, but we'd rather prove it with data. In a head-to-head study, our f/1.3 Raman spectrometer detected [20x lower analyte concentrations](#) than a popular f/4 CT spectrometer. This facilitates analysis of smaller samples, residues, trace concentrations, and markers. It enables applications dominated by expensive benchtop systems & Raman microscopes to escape the lab and see practical use in the field. It makes techniques like SERS, SORS & SESORS more sensitive, and more widely applicable.

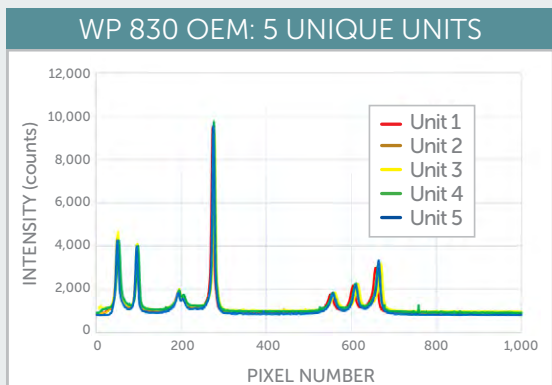

## DEPENDABLE IN VOLUME

Good design yields the same results every time. There are several aspects to this - highly consistent VPH grating efficiency, diffraction-limited optics for tight focusing and conservative tolerances, and simplicity of alignment. Our symmetric f/1.3 design is [inherently manufacturable](#), allowing us to offer  $<\pm 10\%$  unit-to-unit system response matching. Spectral reproducibility over temperature, time, and in volume is crucial to the development of Raman spectral libraries and the accuracy of library matching algorithms, particularly in quantitative or mixture analysis, and we deliver reliably every time.

# Applications that impact our lives &



## FOOD

Quality, safety, and authenticity of our food supply is a real and present issue, and Raman's specificity, sensitivity, and insensitivity to water is an ideal technique to tackle it. We're helping measure moisture & fat content for quality and detect acrylimide in fried foods, fipronil in eggs, & melamine in milk for safety. We work with scientists finding new ways to authenticate [protected domain spirits, spices](#), organic oils, and maple syrup, as well as finding new solutions to improve the food chain.

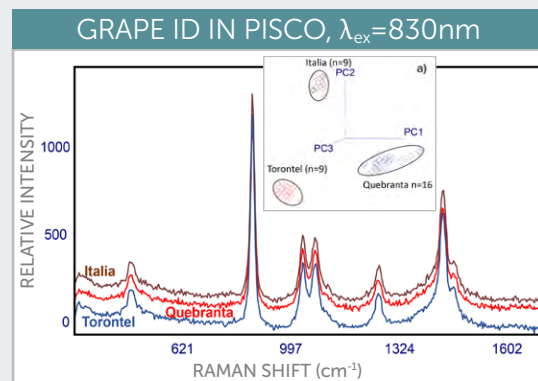

## ENERGY

Our dependence on energy makes it a resource to guard at every stage of production & use. Raman's ability to analyze hydrocarbons and gases can optimize extraction during [mud logging & downhole monitoring](#), and sound the alarm on dangerous gases. It can be used to detect counterfeit and subpar fuels blended with vegetable oil or subsidized fuels via direct detection and sensitive SERS-based markers. It can even analyze the thermochemistry of very hot exhausts.

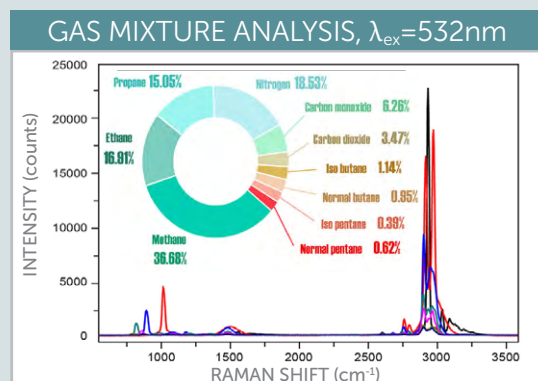

## MATERIALS

The field of materials analysis impacts in every aspect of our lives, from the electronics we depend on to our ubiquitous use of plastics. Raman is a popular method for the analysis of next-generation materials like graphene, carbon nanotubes, nanoparticles, and polymer films. We've used it to validate gemstones, and it can provide valuable information in art analysis. Its speed and specificity is key in plastic identification for recycling, and may be the answer to testing water for microplastics.

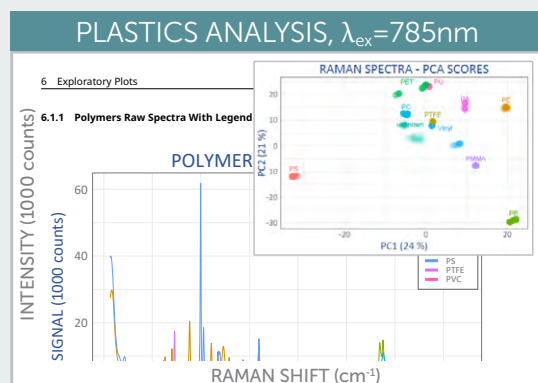

# the world

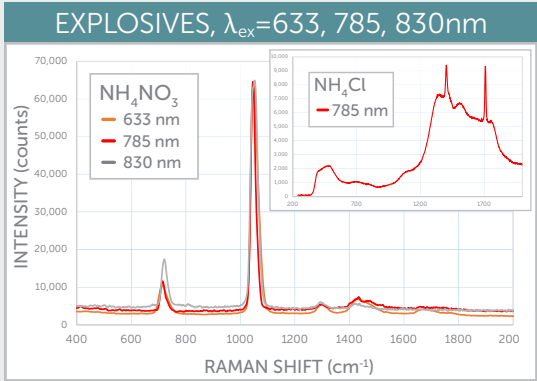

## SECURITY

While Raman has long been used for threat detection, we're enabling new applications and use cases like biological & chemical agents and trace sensing with our sensitivity and speed. First responders, military, and checkpoints rely on Raman for detection of narcotics, explosives & precursors, and we can make that easier. But security has a wider meaning. It includes ID of taggants in valuables, forensic analysis, and even routine uses like detecting ice on roads or water quality testing.

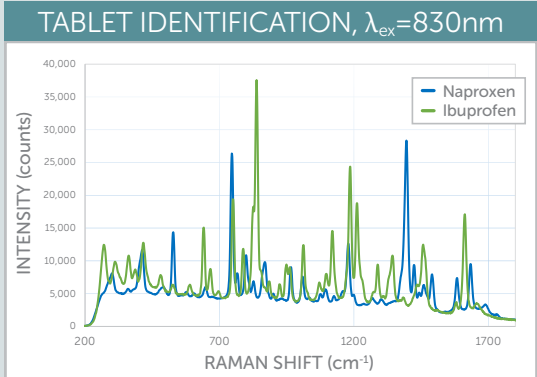

## PHARMA

Raman is an extremely well-established technique in pharmaceutical analysis due to its ability to quickly test raw material ID and purity, provide online quality control of tablet composition & uniformity, and analyze APIs. We see new applications in the field, where our users are testing authenticity of antimalarial drugs or looking for ways to validate drug dosing and ID at point-of-care with a compact, sensitive device. It can even be used to characterize drug delivery in tissues.

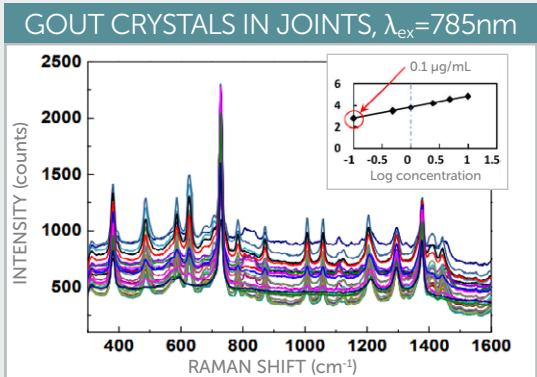

## BIOMED

Medical applications of Raman often strike close to home, and we have the privilege of supporting many at both the research and OEM level. We work with those developing diagnostics for gout, dental caries, and blood glucose, plus researchers using SERS for bacterial detection. We see Raman in cell research, noninvasive testing of blood quality, and tissue measurements. One of the most exciting areas benefiting from our higher sensitivity is cancer and infectious disease detection.



# Products that bring Raman to Life

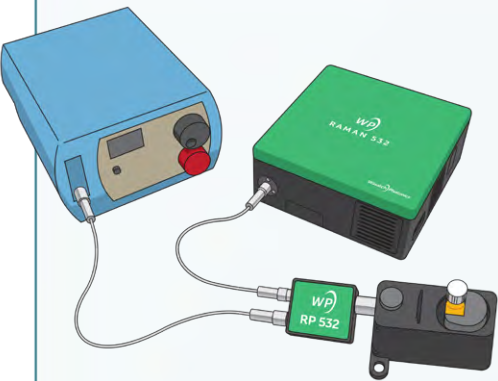

## MODULAR flexibility for research or reach

We'll help you create a [modular system](#) for maximum reconfigurability, whether you're working with patients, on a process line, or in the lab. We offer [free space and fiber-coupled spectrometer models](#) to give you control over light collection and routing, and [standalone lasers](#) to excite with the light you need. Our [Raman probes](#) with flexible fiber connections and adaptable probe head optics can interface with a wide range of samples and optical systems, for detailed measurements at close range, or in harsh conditions and remote locations. To complete your system, we've developed **quick-fit sample holders** that let you switch from slides to cuvettes to vials with ease.

## WAVELENGTH & RANGE

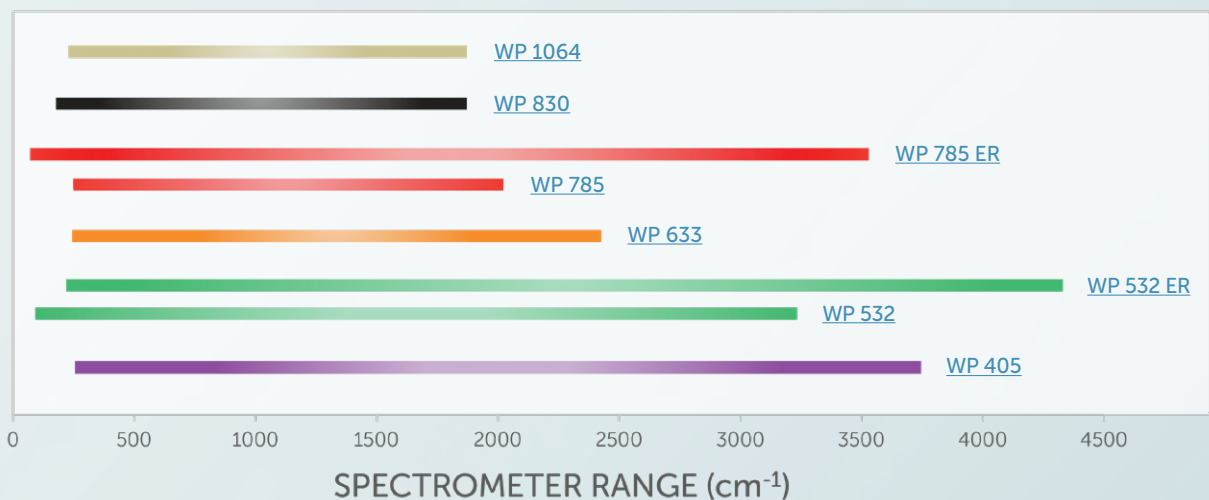

405

532

633

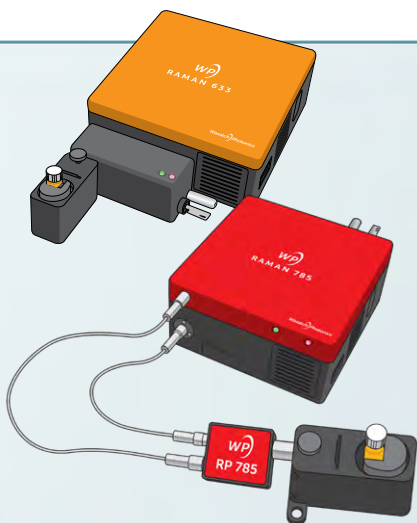

## INTEGRATED for simplicity or size

Need a smaller footprint with all-in-one optics or maximum flexibility? Our laser integration options simplify your system design without compromise. The front-end module of our ['-L' models](#) house a **fully integrated laser and optimized coupling optics** for directly interfacing with your sample in a single, compact footprint. If you want to retain the flexibility of fiber coupling to a probe for remote sampling or dynamic research, our onboard laser design features an excitation laser piggybacked on the spectrometer with only a modest increase in height. The design ensures direct laser activation and power level control through ENLIGHTEN™ software and is secured via an approved laser interlock system with additional LED status indicators for enhanced usability.

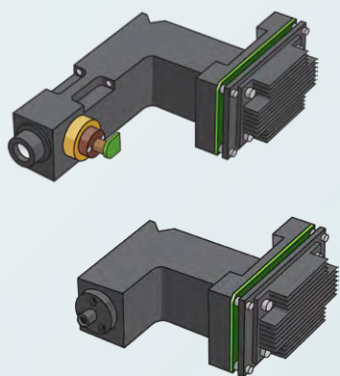

## OEM more compact, same performance

If you're ready to take the next step and develop your own Raman system or solution, we've got the **innovative mindset and applications expertise** to help you create game-changing products. We've developed off-the-shelf, [OEM-ready modules](#) at our most popular wavelengths, designed using the same high performance optics for guaranteed results, and ready to scale to volume. We can also construct [custom optical designs](#) with unique form factors, bespoke gratings, detectors, and sample coupling optics optimized for your application or use case, or create **electronics, software, and interfaces** geared to your operation environment, users, and analysis needs. We are committed to supporting you **from concept through launch**, at every level of the organization.

785

830

1064

# Flexibility to make Raman your own

## EXCITATION WAVELENGTH

It all starts with finding the [right wavelength](#) for your sample to yield high signal & low background. Our superior sensitivity allows you to work at longer wavelengths to reduce absorption and fluorescence when working with organic, light-sensitive, or dark materials, while still achieving surprisingly short measurement times. Our NIR Raman systems deliver [superior SNR](#) in a fraction of the time of other compact systems for research, while many OEMs choose our [830 nm Raman](#) as the perfect compromise between cost and SNR. Let us help you decide with advice, sample testing, or a demo!

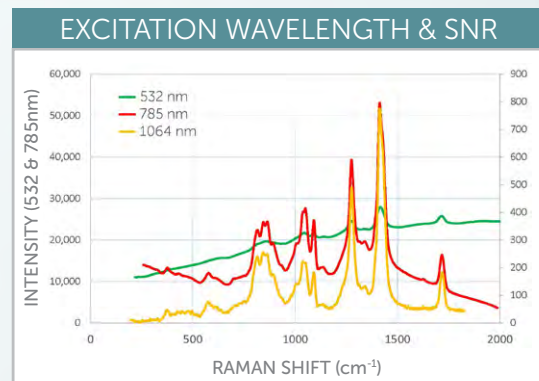

## RANGE & RESOLUTION

Once excitation wavelength has been decided, it comes down to what kind of information you need to extract from your spectra. Will the fingerprint region to 2000 cm<sup>-1</sup> be sufficient for identification or analysis, or are bands further into the IR important? We offer [standard and extended range models](#) out to 4300 cm<sup>-1</sup> with choice of slit size to deliver the resolution you require. We offer basic longpass filters to eliminate laser bleedthrough, but can also use steeper filters as needed. Don't see what you need? Ask about our [custom design options for OEMs](#).

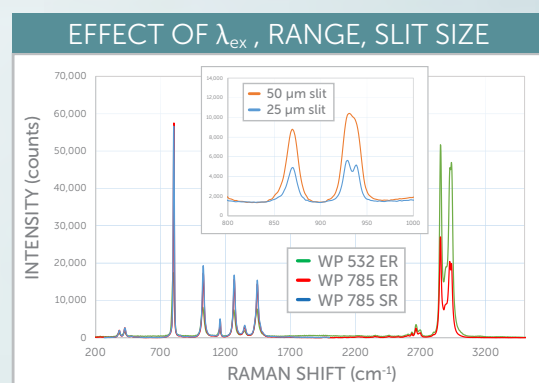

## DETECTOR COOLING

The [choice of detector](#) impacts both noise level and cost, and we can help you find the right fit. An uncooled or 'ambient' detector is the most cost effective option, yielding high sensitivity and good SNR for teaching and lab environments. The next step is a TEC-regulated detector with fixed dark noise for better spectral reproducibility and SNR, great for variable environments and handheld use. When exceptional reproducibility or long measurements are needed, a TEC-cooled detector offers the lowest dark noise for highest SNR and lowest limits of detection.

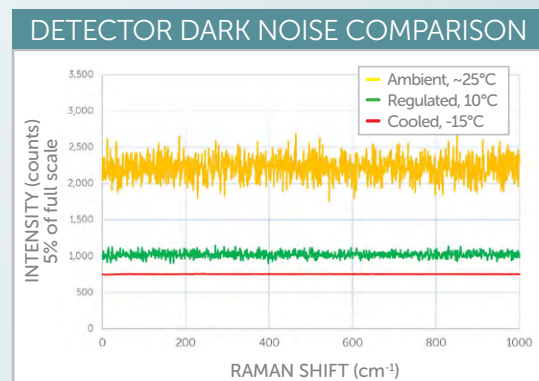



## SAMPLE COUPLING

Samples seldom come in convenient packaging, but we've seen it all. Whether you're working with a solid, gas, or liquid, we can offer or advise on sampling accessories and a configuration to yield the best quality data. We've designed our own compact, flexible fiber optic [Raman probes](#) to be perfectly matched to our f/1.3 design for maximum sensitivity, faster measurements, and best SNR. Our 'quick-fit' accessory approach allows these probes to be easily adapted to microscopes and other optical setups, or mated to a flexible sample holder that fits cuvettes, small & large vials, and slides.



## SOFTWARE SOLUTIONS

We believe that spectroscopy software should be intuitive, easy to learn, packed with convenient features to simplify data acquisition, and it should be free! Our [ENLIGHTEN™ spectroscopy software](#) has all the features and control you need to quickly and easily collect Raman spectra from our spectrometers. View your spectra live, overlay current data with previous scans, or export spectral data for further analysis. [Software development kits \(SDKs\)](#) are also free to enable development of software for many popular platforms: .NET, visual C#, Python, Delphi, LabView, MatLab, and Excel.



## IMPLEMENTATION OEM VS BENCHTOP

Our [drop-in modules for OEMs](#) form the heart of our standard products – in fact, our optical bench is our OEM bench – allowing you to perform R&D with our standard products and then migrate to the OEM equivalent for prototyping and production with no loss of performance. The high consistency between our standard and OEM products [accelerates product development](#) while reducing risk, and aids transfer of chemometric models or Raman libraries for matching. Ask us about our [custom design capabilities!](#)



Where many see a world full of problems, we see undiscovered solutions. While the path there is rarely direct, a willing force will find its way. At Wasatch Photonics, our products provide the power behind your ideas to solve complex issues, understand the world around us, and unlock answers to the challenges we face as citizens of our world. Every idea is precious, every solution is unique, and by looking at things from a shared perspective, [we can find our way there together.](#)

*Wasatch*) Photonics

PHONE: +1 919-544-7785 | EMAIL: [info@wasatchphotonics.com](mailto:info@wasatchphotonics.com) | [wasatchphotonics.com](http://wasatchphotonics.com)