

LINSEIS

T H E R M A L A N A L Y S I S

**Optical Dilatometer
Heating Microscope**

DIL L74

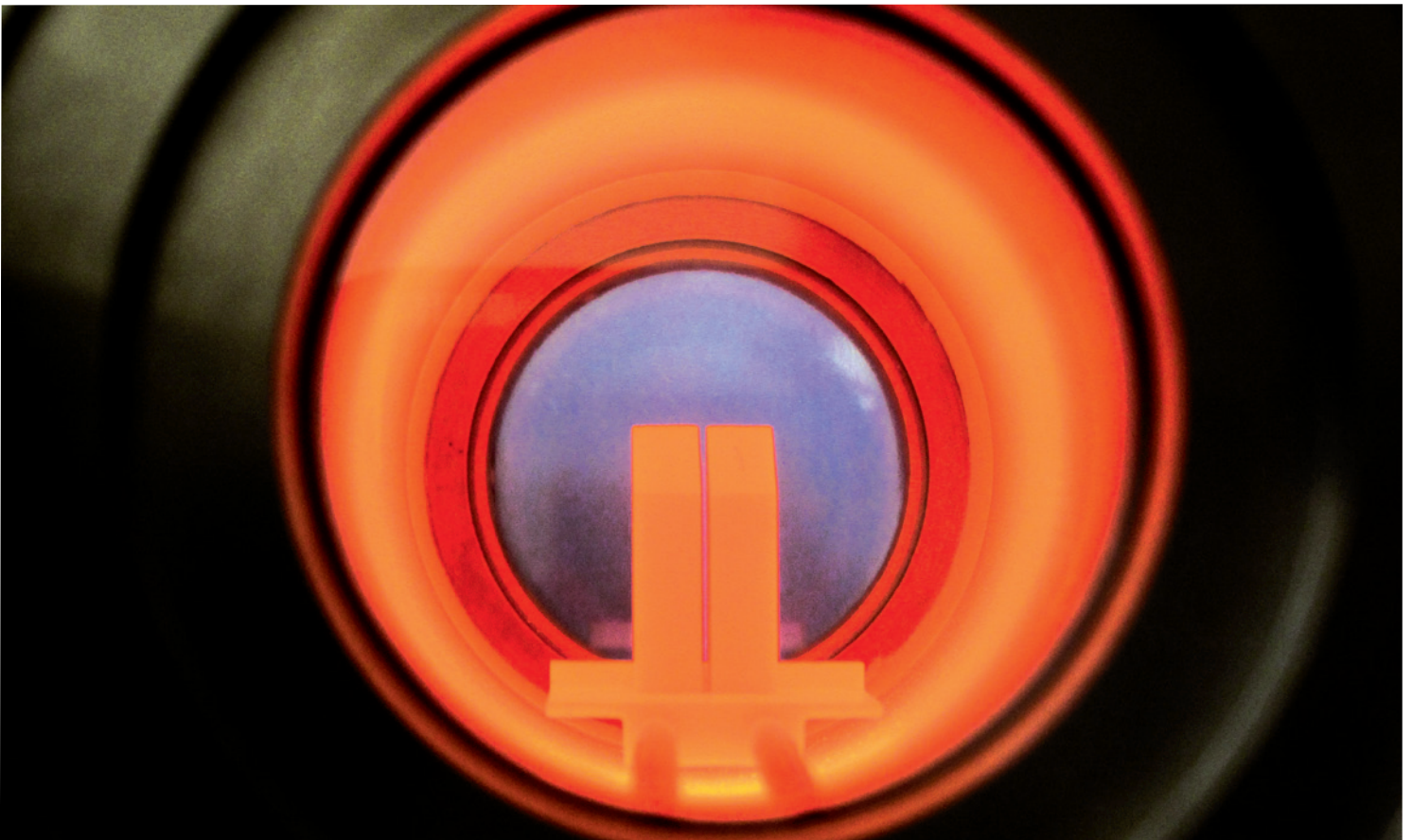

Since 1957 LINSEIS Corporation has been delivering outstanding service, know how and leading innovative products in the field of thermal analysis and thermo physical properties.

Customer satisfaction, innovation, flexibility and high quality are what LINSEIS represents. Thanks to these fundamentals our company enjoys an exceptional reputation among the leading scientific and industrial organizations. LINSEIS has been offering highly innovative benchmark products for many years.

The LINSEIS business unit of thermal analysis is involved in the complete range of thermo analytical equipment for R&D as well as quality control. We support applications in sectors such as polymers, chemical industry, inorganic building materials and environmental analytics. In addition, thermo physical properties of solids, liquids and melts can be analyzed.

LINSEIS provides technological leadership. We develop and manufacture thermo analytic and thermo physical testing equipment to the highest standards and precision. Due to our innovative drive and precision, we are a leading manufacturer of thermal Analysis equipment.

The development of thermo analytical testing machines requires significant research and a high degree of precision. LINSEIS Corp. invests in this research to the benefit of our customers.



Claus Linseis
Managing Director

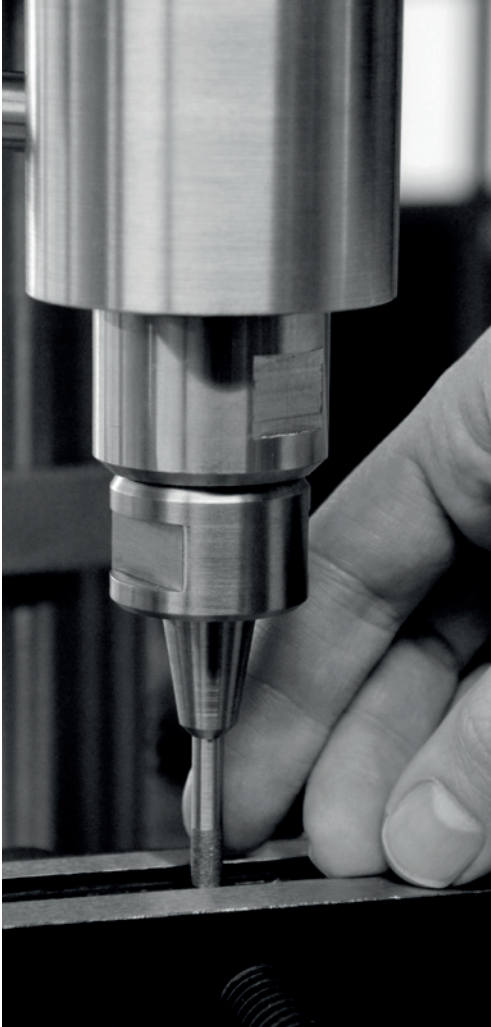

German engineering

The strive for the best due diligence and accountability is part of our DNA. Our history is affected by German engineering and strict quality control.

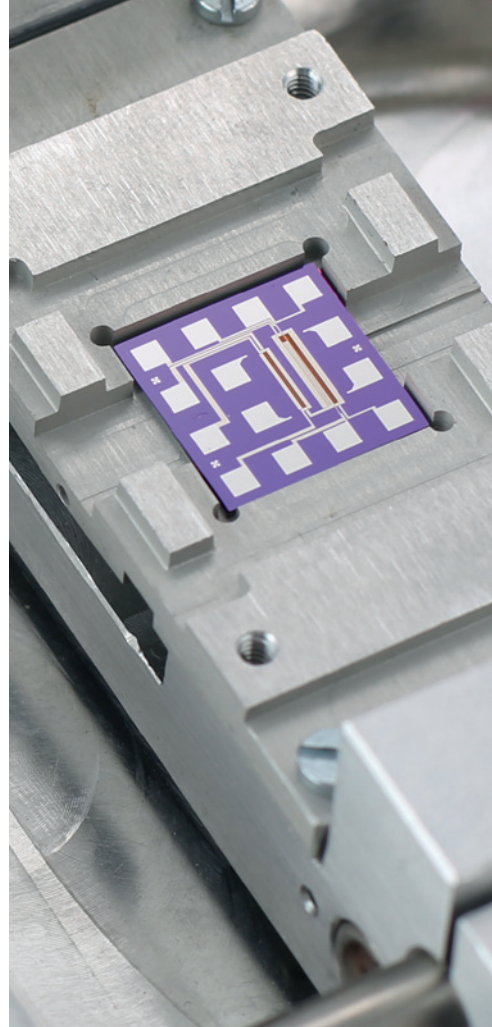

Innovation

We want to deliver the latest and best technology for our customers. LINSEIS continues to innovate and enhance our existing thermal analyzers. Our goal is constantly develop new technologies to enable continued discovery in Science.

OPTICAL DILATOMETER

The Optical Research Dilatometer L74 was developed to meet the demanding applications of the glass, ceramics, metal and energy industry. A high resolution CCD camera enables a visual real time analysis of the sample expansion, either as single frame or as video sequences. The big advantage of this method is that the

sample is not burdened with any force. For soft samples or samples that melt during the measurement, this leads to a result, which is not distorted by the contact pressure.

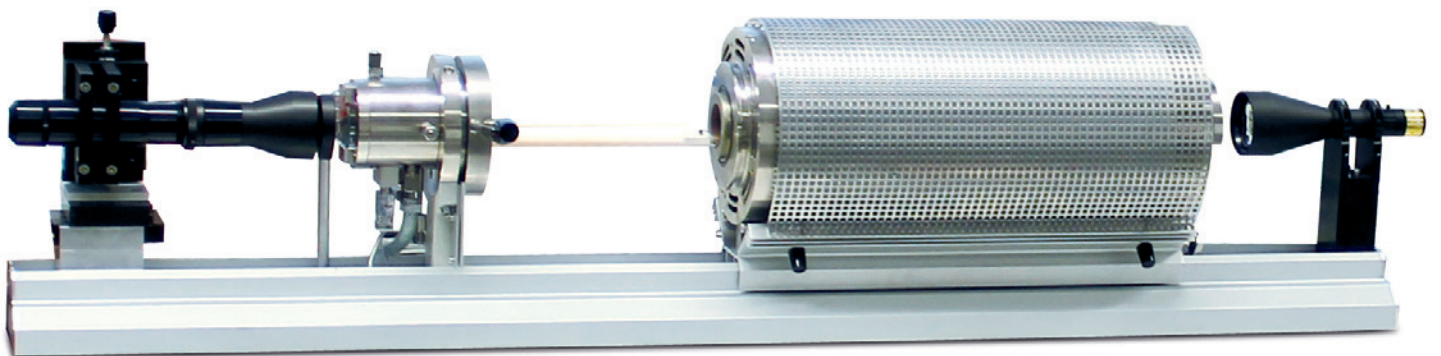

DSC - Differential Scanning Calorimeter Option

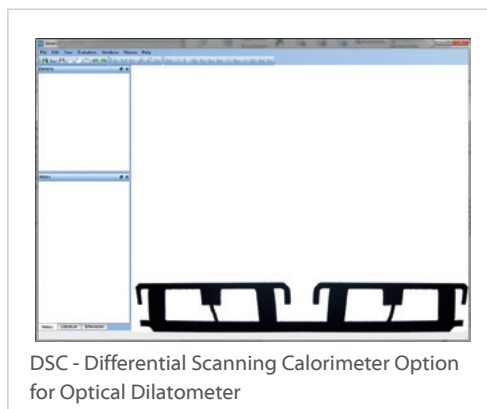
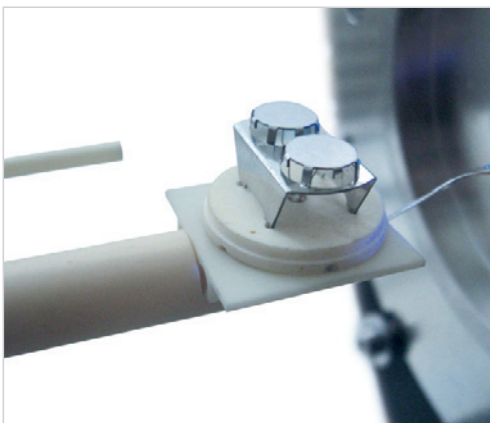

DSC - Differential Scanning Calorimeter Option for Optical Dilatometer

Several correction and analysis features are incorporated into the LINSEIS Evaluation Software. The unique horizontal design enables most demanding applications. The special solid-liquid adapter allows expansion / volume measurements of solids, liquids and solid – liquid phase transitions. There is also a special sample holder for measuring rigid foils available, which avoids measurement errors due to pushrod forces like in a classical dilatometer.

Application

- analysis of sintering processes (densification behavior as a function of temperature and time → sintering kinetics)
- analysis of the thermal expansion behavior (thermal expansion coefficient)
- investigation of the wetting- and spreading-behaviour of metallic- and glass-melts, slags and ashes on different substrates (metal, ceramic, glass)
- optical determination of the drop shape and contact-angle → determination of surface tension up to high temperatures
- analysis of the softening - and melting behavior (melting kinetic)
- investigation of corrosion behavior (metallic- and glass-melts, slags etc. on refractory materials)
- analysis of the ash melting behavior

- determination of viscosity curves of glasses
- analysis of sintering warpage (sintering of ceramic tapes and multilayers; co-sintering of metal-ceramic bi- and multi-layers)
- analysis of the infiltration behavior of metallic melts in ceramic materials (synthesis by melt-infiltration)
- analysis of melt filtration by porous ceramic materials
- investigation of the coating behaviour
- analysis of the brazing behavior and brazing tests, solder development, glass-metal or ceramic sealing

Industries

- glass
- metal
- enamel coatings
- ceramics
- energy

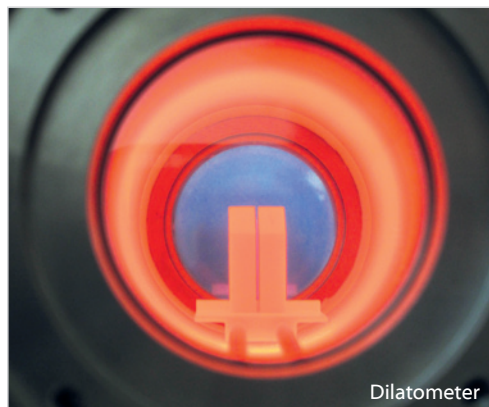

OPTICAL DILATOMETER

Sintering

The investigation of sintering processes using pushrod dilatometers has one disadvantage: There is always a force in z-direction that can cause a certain sinter direction. The optical dilatometer instead is able to measure a sinter process completely contact free and guarantees

that the sintering process can take place without any influence. If you compare the results of the same substance that was sintered on an optical and on a pushrod dilatometer, there can be big differences because of this effect.

Sintering behaviour of ceramic tapes (ZrO_2)

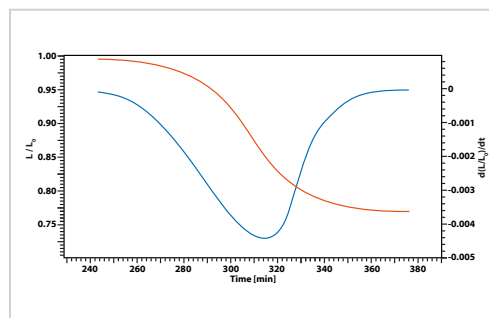
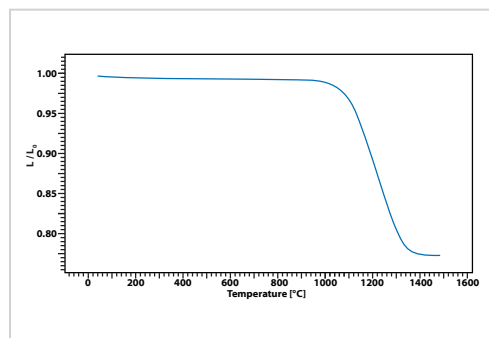
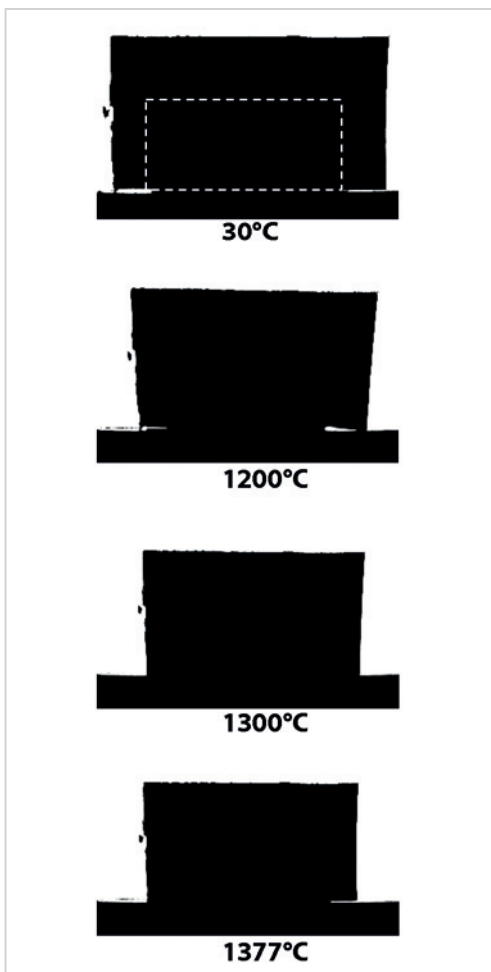

HEATING MICROSCOPE

Applications

- Ash fusion microscopy
- Observation and analysis of sintering processes
- Contact angle determination
- Microscopy at high temperatures and under different atmospheres

Ash melting microscope

Ash melting of a coal sample

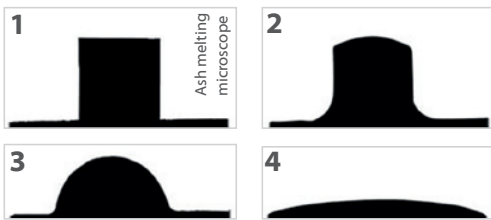

- 1 – Softening temperature = edges are getting round
- 2 – spheric temperature = round shape of height that is as big as its baseline
- 3 – half sphere temperature = half sphere shape of height that is half the size of its baseline
- 4 – flow temperature = sample is nearly liquid, has only one third of the size of half sphere point

General

Solid ash fuels consist of inorganic compounds like silicon oxide and alkali oxides. Due to the high diversity of ash compositions it is nearly impossible neither to define a universal melting point nor to determine a fuel specific melting point. The melting behavior of ashes is heavily dependent on its chemical composition. The melting procedure of ashes takes place in a broader temperature range. Even if the slagging problems of power plants are different from each other, the melting behavior of ashes is useful to get a qualitative analysis of the slagging behavior of different coals what gives a result that can be applied to the corresponding boiler. The ash melting behavior of coals is determined according to DIN 51730, for bio

mass there is a pre norm DIN CEN/TS 15730 that can be used as well. It defines four characteristic temperatures under oxidizing atmosphere.

Functional Principle

The principle of determination of the ash melting behavior is based on a sample that is melted under defined temperature ramps. The melting temperatures for stone coal are up to 1600°C, for bio mass and wood they are at around 1200°C to 1300°C and for culm containing bio mass they are even lower. The evaluation is done automatically according to DIN 51730 by monitoring of a shadow profile of the sample where the change of geometry is documented. By means of operating geometric factors, the resulting characteristic temperatures can be determined and be used for comparison of different coal qualities.

Fields of Application

- Measurements according to DIN 51730 (1984, 1998) / ISO 540-1995
- Characteristic temperatures plus start of sintering / sintering point
- Ash melting behavior
- Sintering behavior
- Dilatometric curves (e.g. shape, area)
- Softening- and melting behavior, moistening behavior
- Viscosity curve

Suitable for analysis of coal ashes, bio ashes, slags, as well as ceramic, enamel, clay ceramics, dental ceramics, grinding discs, special ceramics, fire proof ceramics, glass, steal, soldering pastes, stainless steel and fluxing agents.

SOFTWARE

Features -Software

In respect to thermal and mechanical sample treatment numerous different mathematical functions can be selected.

- User-friendly
- Multi-methods analysis (DSC TG, TMA, DIL, etc.)
- Zoom function
- Online help menu
- Report generator
- Data export to MS Excel
- Export and import of data ASCII
- Program capable of text editing
- Data security in case of power failure
- Thermocouple break protection
- Repetition measurements with minimum parameter input
- Evaluation of current measurement
- Curve comparison up to 32 curves
- Storage and export of evaluations
- Programmable gas control
- Statistical evaluation package
- Smoothing of total or partial measurement
- Tangent intersection determination (automatic or manual)
- Free scaling

The information of a thermo analytical measurement can be increased when using the broad range of specialized Software.

Software options

- Specific Heat determination (Cp)
- Rate Controlled Sintering (RCS)
- Calculated-DTA

- Quenching Dilatometer Software
- CHT / CCT / DCCT / TTT Diagrams
- Thermo Kinetics Software

Control and Evaluation Software

- Software package compatible with Windows 7 and 8
- Software for creation of CHT, CCT, DCCT and TTT diagrams
- all necessary measuring parameter are included in the menu structure
- Unlimited number of forming steps during measurement
- free choice of all control parameters
- Specification of temperature-time force-gradient and strain rate and deformation degree
- Control rate input by user or selection of industry parameter, i.e. quenching rates based on $T_{8/5}$ times
- Automatic force control on the basis of user defined functions
- individual commentaries
- heat up and cool down speeds
- end of the heating curve as well as duration of holding temperature
- programmable heating / cooling and isothermal segments
- function menus are easy to handle
- Graphical evaluation software with many functions to get complete results of all measured data

- Free assignment of axes
- The evaluation software includes freely scalable isothermal and continuous diagrams
- Manual entry of transition points
- Correction of individual data points
- Insertion of text
- ASCII Export
- Calculation of Delta L, Alpha physical, Alpha technical (CTE)
- Mathematical calculation of curves
- Statistical evaluation of curves with mean and confidence interval
- Print out of the results as curve or table
- Evaluation can be done simultaneously to an ongoing measurement / multi tasking
- Measuring data will be corrected through correction curve mal segments
- function menus are easy to handle
- Graphical evaluation software with many functions to get complete results of all measured data

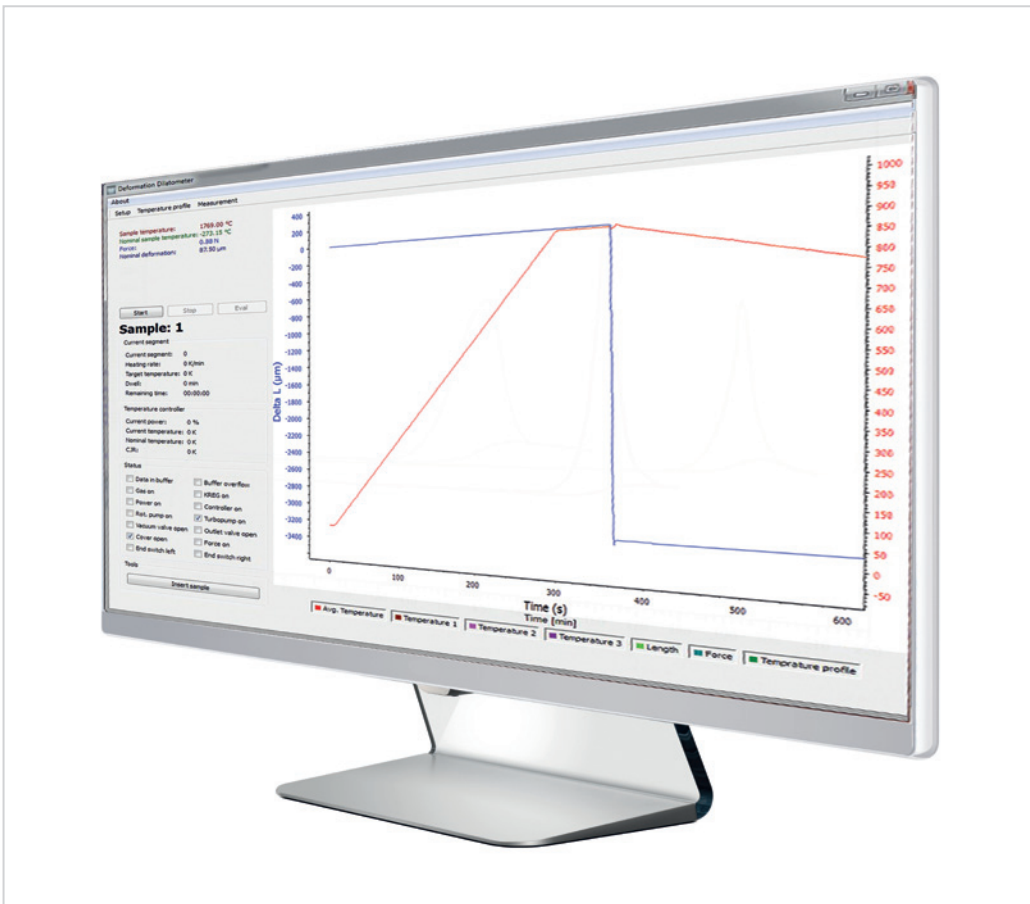

SPECIFICATIONS

	DIL L74
Maximum furnace temperature	RT up to 1600 / 1800 / 2000°C
Temperature at specimen	RT up to 1550 / 1700 / 2000°C
Heating rate	up to 50°C/min (depends on furnace)
Temperature resolution	0.2°C
Sample dimensions (WxHxD)	24 x 22 x 40 mm
Resolution	up to 1µm or 3ppm (with standard sample)
Vacuum	up to 10 ⁻⁵ mbar (depends on pump and selected furnace)
Hydrogen atmosphere	optional hydrogen safety system available
Measuring range contact angle	0...180°; +/- 0.1°
Calibration standards	calibration standard with table included
Detection Modes	Sintering, Softening point, Deformation point, Sphere, Half-sphere, Melting Point, CTE coefficient of thermal expansion, Linear and Volumetric thermal expansion, Contact Angle, Surface tension, Volume, Symmetry, Asymmetry, Height, Width Ration, many others
International Standards	ASTM C372, ASTM D1857, CEN/TR 15404, BS 1016: Part 15, CEN/TS 15370-1, DIN 51730, IS 12891, ISO 540, NF M03-048

APPLICATIONS

Sintering of Alumina Oxide (Al₂O₃)

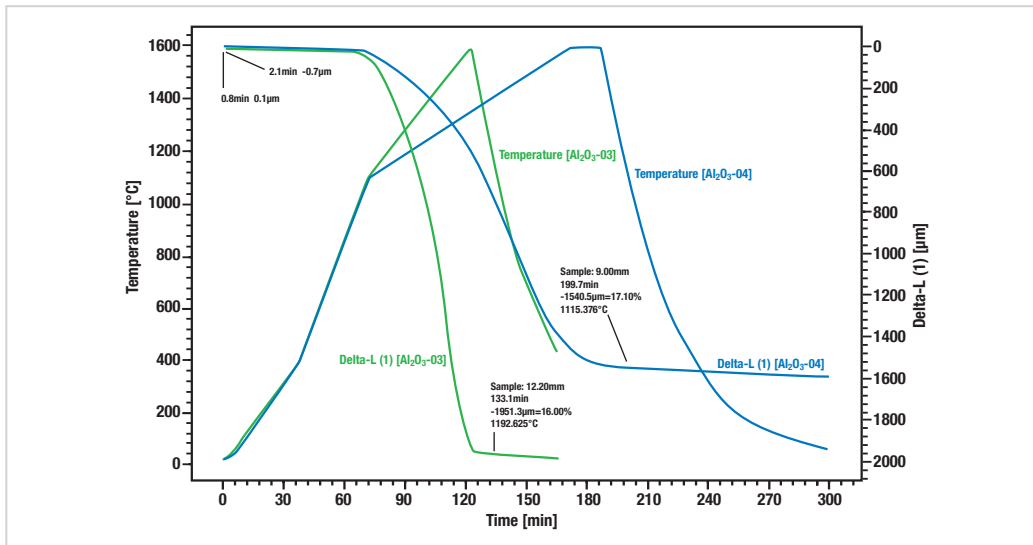

Up to a temperature of 1100°C no sintering behavior can be detected at both samples. With the following slower heating rate and a dwell time of 15 min at 1600°C sample two (blue curve) shows a shrinkage of 17.11%,

Comparison

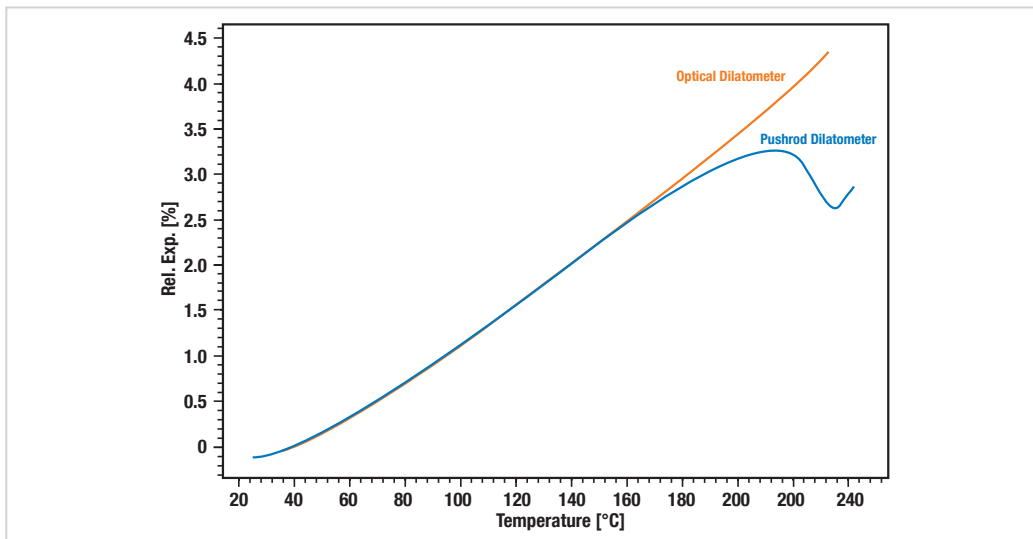

Comparison between Conventional and Optical Dilatometer when evaluating the expansion of an epoxy resin into the melting stage.

**LINSEIS GmbH Germany**

Vielitzerstr. 43

95100 Selb

Tel.: (+49) 9287 880 0

Fax: (+49) 9287 70488

E-mail: info@linseis.de**LINSEIS Inc. USA**

109 North Gold Drive

Robbinsville, NJ 08691

Tel.: (+1) 609 223 2070

Fax: (+1) 609 223 2074

E-mail: info@linseis.com**LINSEIS China**

Kaige Scientific Park 2653 Hunan Road

201315 Shanghai

Tel.: (+86) 21 6190 1202

Fax.: (+86) 21 6806 3576

**LINSEIS France**

Bureaux Paris

52 Boulevard Sébastopol

75003 Paris

Tel.: (+33) 1.73.02.82.72

Bureaux Lyon

2A Chemin des Eglantines

69580 Sathonay Village

Tel.: (+33) 4.26.68.70.55

**LINSEIS Poland**

ul. Dabrowskiego 1

05-800 Pruszkow

Tel.: (+48) 692 773 795

www.linseis.com**Products:** DIL, TG, STA, DSC, HDSC, DTA, TMA, MS/FTIR, In-Situ EGA, Laser Flash, Seebeck Effect, Thin Film Analyzer, Hall-Effect**Services:** Service Lab, Calibration Service

05/18

RMI, s.r.o.

Pernštýnská 116

533 41 Lázně Bohdaneč

Tel: 466 921 885, 404

e-mail: sale@rmi.czweb: www.rmi.cz**LINSEIS**