

**LINSEIS**

T H E R M A L   A N A L Y S I S

**WATER VAPOR  
AND  
RELATIVE  
HUMIDITY**

L40/WV and  
L40/RH



---

Since 1957 LINSEIS Corporation has been delivering outstanding service, know how and leading innovative products in the field of thermal analysis and thermo physical properties.

Customer satisfaction, innovation, flexibility and high quality are what LINSEIS represents. Thanks to these fundamentals our company enjoys an exceptional reputation among the leading scientific and industrial organizations. LINSEIS has been offering highly innovative benchmark products for many years.

The LINSEIS business unit of thermal analysis is involved in the complete range of thermo analytical equipment for R&D as well as quality control. We support applications in sectors such as polymers, chemical industry, inorganic building materials and environmental analytics. In addition, thermo physical properties of solids, liquids and melts can be analyzed.

LINSEIS provides technological leadership. We develop and manufacture thermo analytic and thermo physical testing equipment to the highest standards and precision. Due to our innovative drive and precision, we are a leading manufacturer of thermal Analysis equipment.

The development of thermo analytical testing machines requires significant research and a high degree of precision. LINSEIS Corp. invests in this research to the benefit of our customers.



**Claus Linseis**  
Managing Director

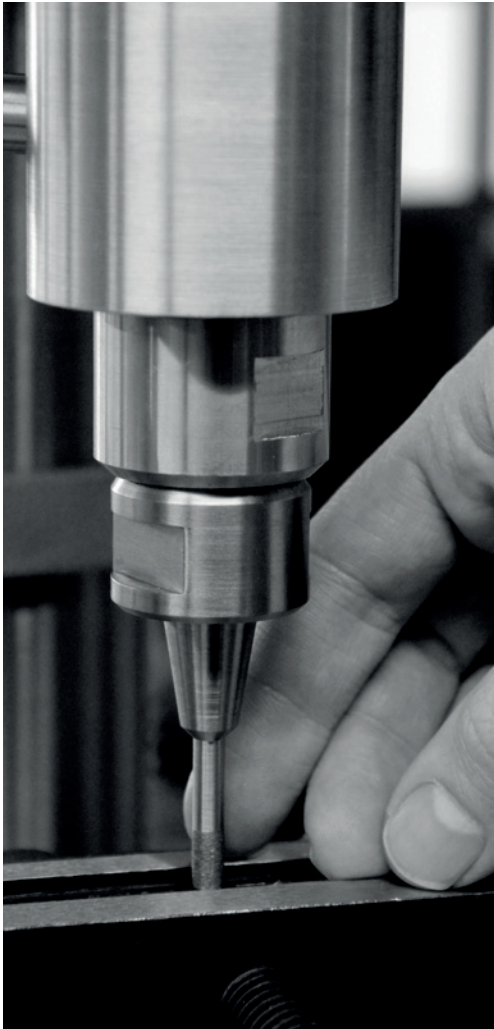

## German engineering

The strive for the best due diligence and accountability is part of our DNA. Our history is affected by German engineering and strict quality control.

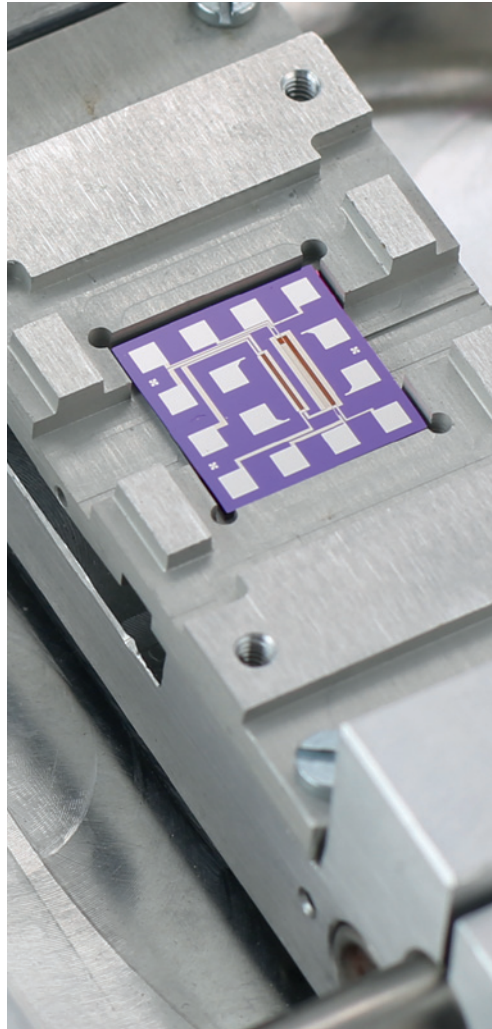

## Innovation

We want to deliver the latest and best technology for our customers. LINSEIS continues to innovate and enhance our existing thermal analyzers. Our goal is constantly develop new technologies to enable continued discovery in Science.

# Linseis equipment for operation under water vapor and relative humidity



Fig 1: Relative Humidity Generator

L40 Water Vapor

For many applications in thermal analysis, the atmosphere plays an important role as it may affect the sample behavior or activate reactions. Humidity influence on building materials, storage time of pharmaceuticals and foods or influence on mechanical properties of polymers are just some of the most common examples. Of course, the Linseis instruments are suitable

for such experiments, however there is one fact that is often causing confusion and must be considered carefully: **The difference between water vapor and relative humidity. Relative Humidity Generators (Fig. 1) are most commonly used for experiments around room temperature, while water vapor applications are most often at higher temperatures.**

## Difference between water vapor and relative humidity

When water is heated to its boiling point or higher than that, the water changes its aggregate form from liquid to gaseous. It is then existing as water vapor (steam). If this steam is introduced into any kind of reaction chamber or instrument, it is called **water vapor application**. In contrast, every gas can transport and contain

a certain amount of water at a given temperature. **This is called humidity**. Considering air as an example, there is always an amount of water contained in the air, even below the boiling point of water, which is defined as grade of humidity or relative humidity. In the following chapters, the difference shall be shown:

# RELATIVE HUMIDITY

## L40/RH

The typical temperature range for humidity generator is between room temperature and 80°C with a controllable relative humidity from 0.2% up to 98%. This can be used for applications in thermal analytical devices, like **Dilatometers, Differential Scanning Calorimeters or Simultaneous Thermal Analyzers**, especially for the analysis of food, pharmaceuticals, building materials or biological processes.

That means, the same amount of water, or more precisely, water vapor in the air (grams H<sub>2</sub>O per kilogram of air) translates into different relative humidity levels, depending on the temperature, as the capacity of the atmosphere changes. This maximum amount of water (capacity) is highly temperature dependent and varies from a fraction of grams per cubic meter (at temperatures

below 0°C) to about 600 grams per cubic meter at 100 °C (Fig. 2).

**If the relative humidity is between 0.1% and 100%, the water can exist in the form of water vapor.** If a relative humidity of 100% is reached and the ambient air is cooled down, the Dew Point (which defines the maximum amount of water, which the air can hold at a specified temperature, see Fig. 3) is exceeded and the water condenses from the air, in the form of liquid water. The residual is an equilibrium between liquid water and water vapor at the specific temperature.

On the other side, if the temperature is increased above the boiling point of water (100°C at sea level conditions), the water in the air can only exist in the form of water vapor.

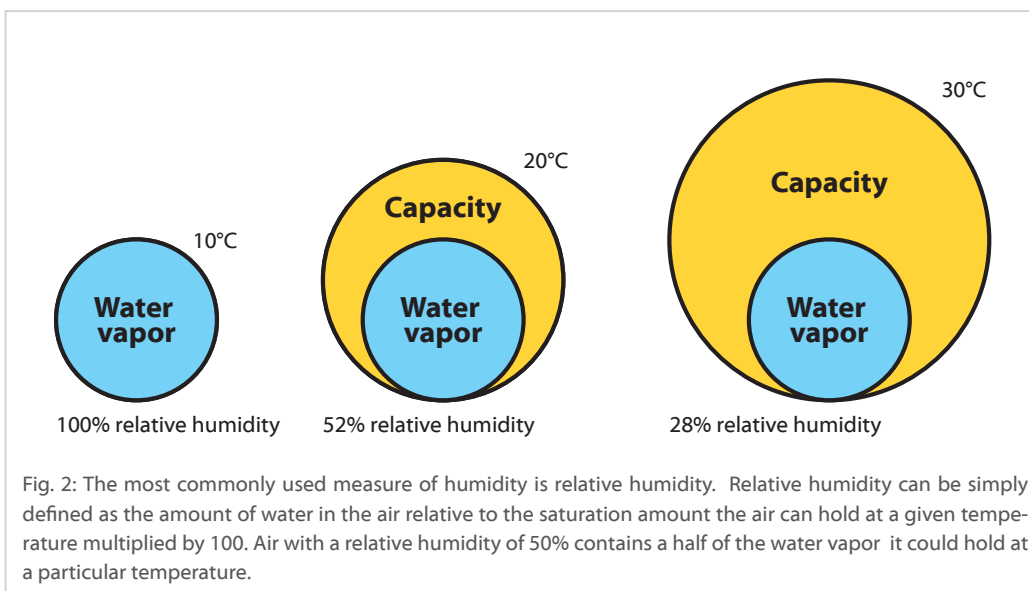

Fig. 2: The most commonly used measure of humidity is relative humidity. Relative humidity can be simply defined as the amount of water in the air relative to the saturation amount the air can hold at a given temperature multiplied by 100. Air with a relative humidity of 50% contains a half of the water vapor it could hold at a particular temperature.

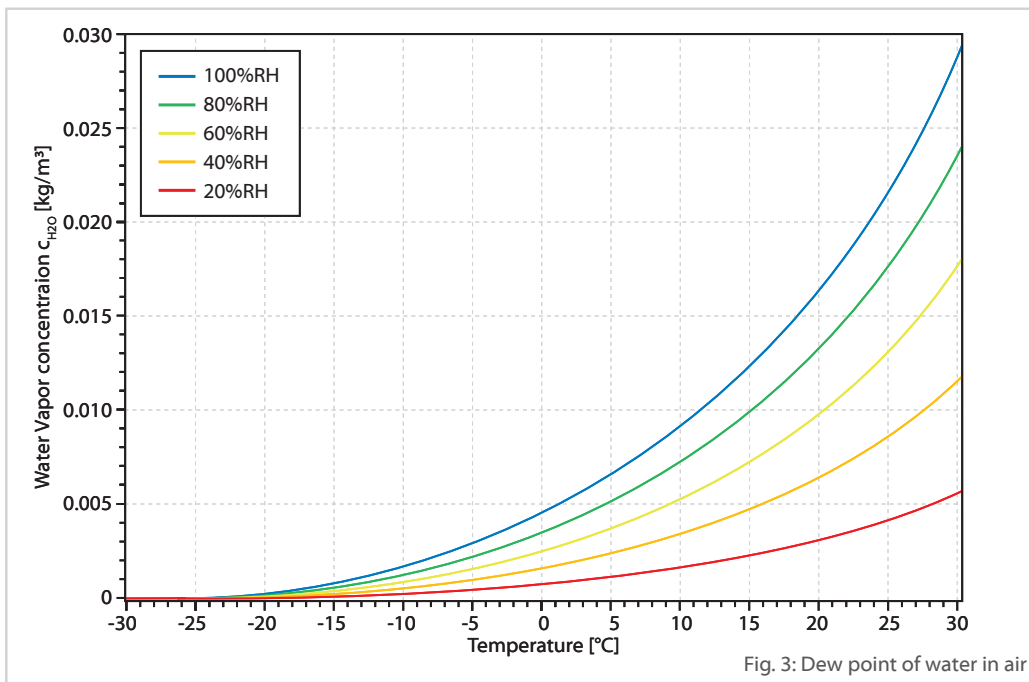

Fig. 3: Dew point of water in air

In particular, with regard to the living conditions on earth, the indication of the relative humidity is very helpful, since the very narrow range of water vapor concentration in which a mammal, like humans, feels comfortable, can be graphically represented by the indication of the relative humidity (see Fig. 4).

This leads to two main application cases for thermal analytical applications. The first one is a temperature sweep application where a defined humidity level at room temperature is set and the sample, including environment, will be heated up or cooled down to a preset temperature. In this case, the amount of water inside the measurement chamber stays constant, but the relative humidity changes as a function of temperature

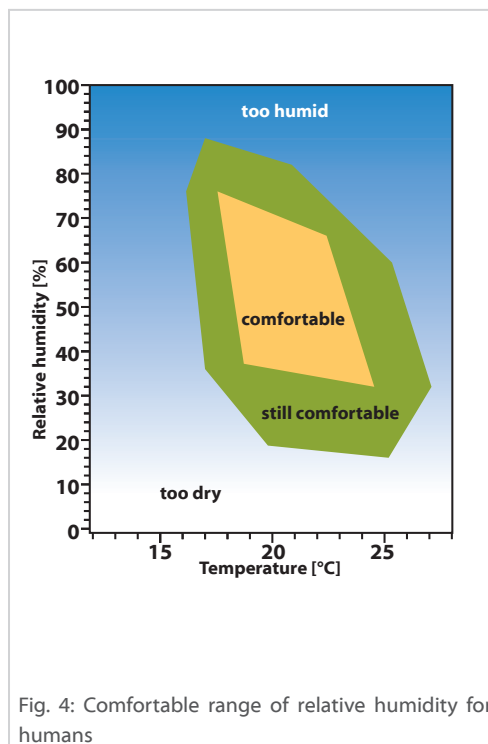

Fig. 4: Comfortable range of relative humidity for humans

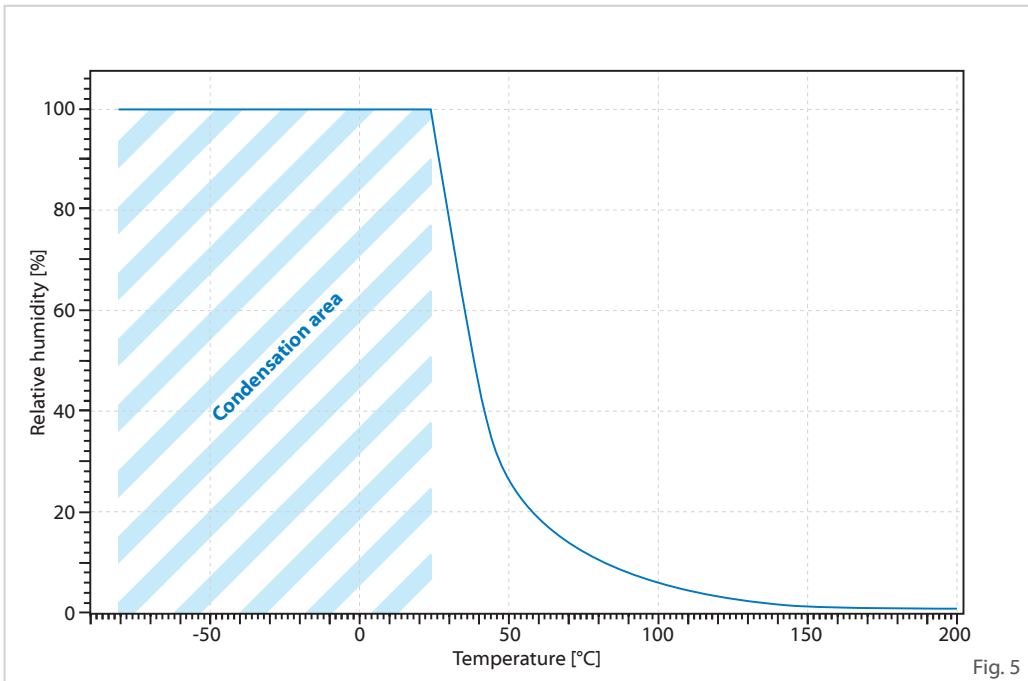

Fig. 5

The other possibility is to measure under isothermal conditions, which allows to set defined and constant humidity levels between 0.2% and 98% relative humidity. Below room temperature, cold air below 0°C, can also hold water in the form of water vapor, but only a limited amount (see Fig. 5). As soon as the rela-

tive humidity is above the dew point (e.g. during cooling down), the water vapor condenses to the form of moisture and, if the surrounding temperature is below 0°C, it will freeze. This procedure requires more extensive hardware equipment, e.g. a heated transfer line for sample temperatures above room temperature.

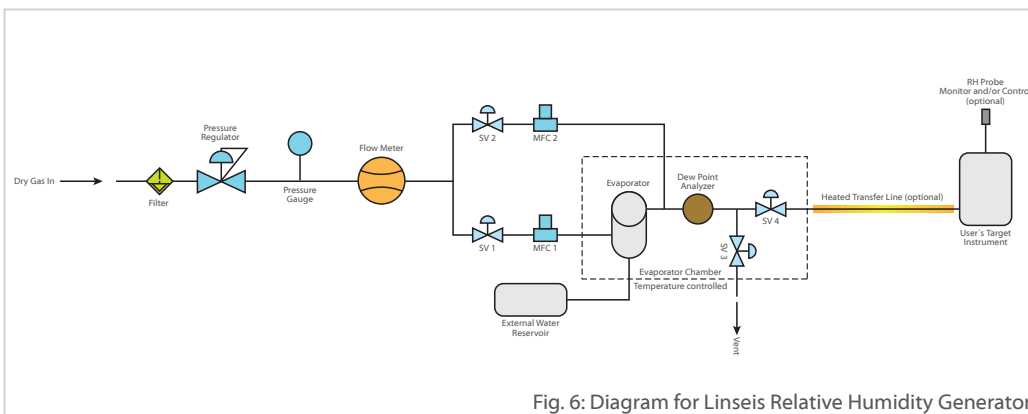

Fig. 6: Diagram for Linseis Relative Humidity Generator

A humidity generator (Fig. 6) creates a water vapor-containing atmosphere by passing a gas through warm water and so saturating it. Thereafter, the gas is adjusted to 100 % RH by adding dry

air to a predetermined relative humidity using a dew point sensor. Custom configurations for carrier gas and compositions can be ordered, using additional MFCs or external dew point sensors.

**A typical application example for a measurement in relative humidity can be found in Fig. 7, where the influence of moisture on the thermal expansion of two different brick materials is investigated:**

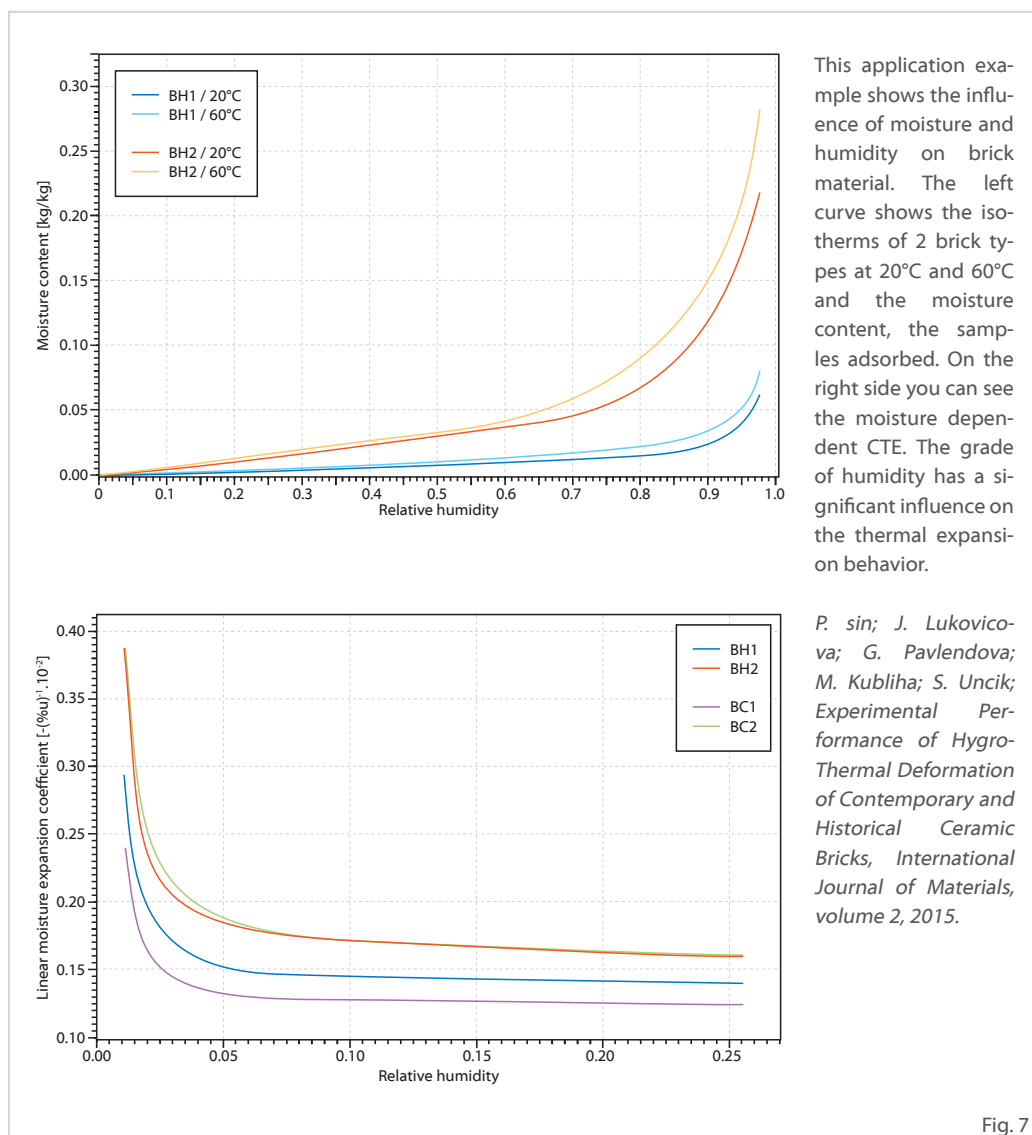
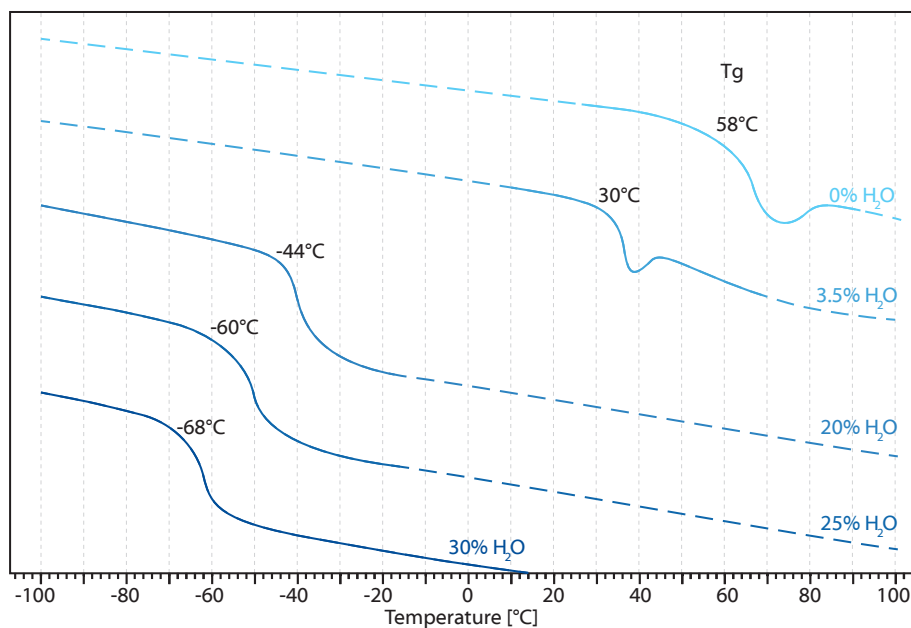

Fig. 7

Another common application field is the influence of humidity on foods (Fig 8):

Fig. 8



In food industries, the water sorption of food solids such as sugars, salts, fats and many more are affecting the melting and crystallization behavior as well as the solubility and therefore storage times, aging behavior and last but not least the taste. In this example, the shift of the glass transition of a sugar, sucrose, was observed by DSC at different humidity levels. The water plasticization

of amorphous sucrose as detected in DSC thermograms (heating rate 5 K/Min) is similar to the behavior of polymers and clearly shifts the glass transition from 62°C for the dry sugar to -68°C at 30% humidity.

*Y. H. Roos, Phase transitions and transformations in food systems, handbook of food engineering, 2006.*



Also the sorption of inorganics and polymers has a certain influence, like in the following example in Fig. 9:

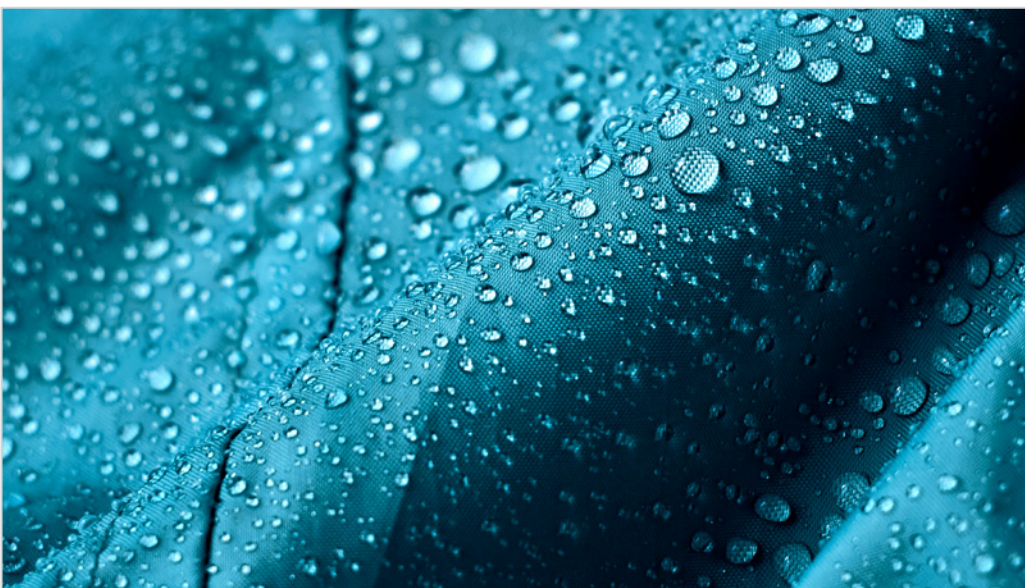
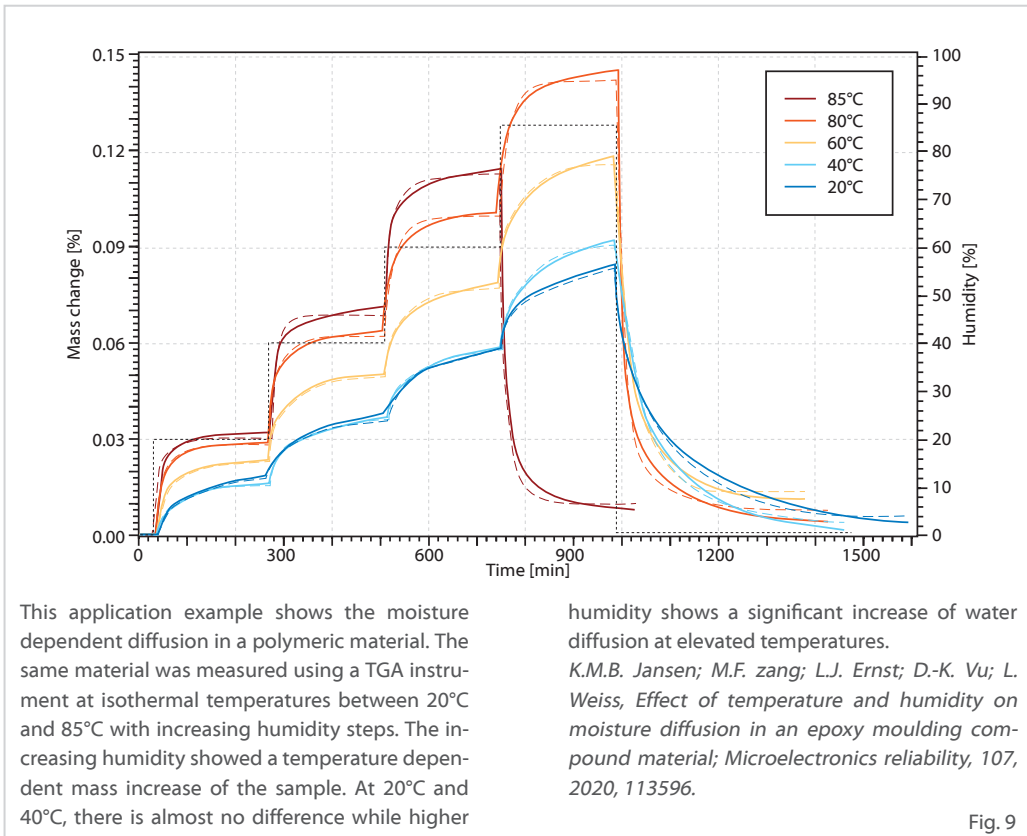

# WATER VAPOR L40/WV

In contrast to the relative humidity, above the pressure dependent boiling point, which is 100°C at sea level conditions, water is only existent in its gaseous phase, in the form of water vapor. By mixing water vapor, produced in a water vapor generator, with a carrier gas like air, nitrogen or helium, variable concentration (in Vol.-%, wt.% or ppm) of the water vapor in the sample gas can be adjusted within our analyzers. In addition, depending on the application, the gas atmosphere within the device can be static or dynamic. Typical investigations for dynamic water vapor atmospheres include isothermal heating of a sample and subsequent dosing of a defined water vapor concentration to induce a reaction. This can be for example adsorption, desorption, reduction, oxidation or transformation measurements.

**In thermal analysis, water vapor generators are typically used in combination with thermobalances like TGA and STA (at elevated pressure range) as well as dilatometers.**

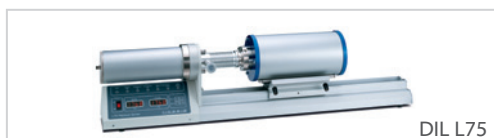

DIL L75

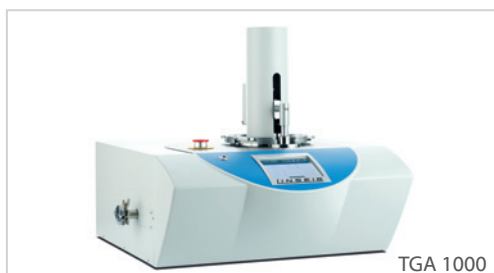

TGA 1000

## Pressure dependent measurements under water vapor atmospheres

In addition to the concentration and the temperature, the pressure level of the atmosphere can be controlled, as it has a big influence on the experiment. A high-pressure level is especially of interest for shifting of the equilibrium conditions of reactions, e.g. for coal or biomass gasification, which can be investigated using our **High Pressure STA Analyzers**.

Nevertheless, with increasing the pressure level, new boundary conditions have to be considered. For example, an increase of the pressure level shifts the boiling point to higher temperatures, until it reaches the so-called critical point (Fig. 10). On the other side, the maximum pressure level of gaseous water is defined by the saturation vapor pressure curve. If the pressure gets to high, the water will condense. For higher temperatures or pressures, above the critical point, the density of the liquid water is just as big as that of the gaseous water, so it cannot condense any more. This is called a supercritical state, e.g. superheated water vapor (see Fig. 10).



STA PT 1000

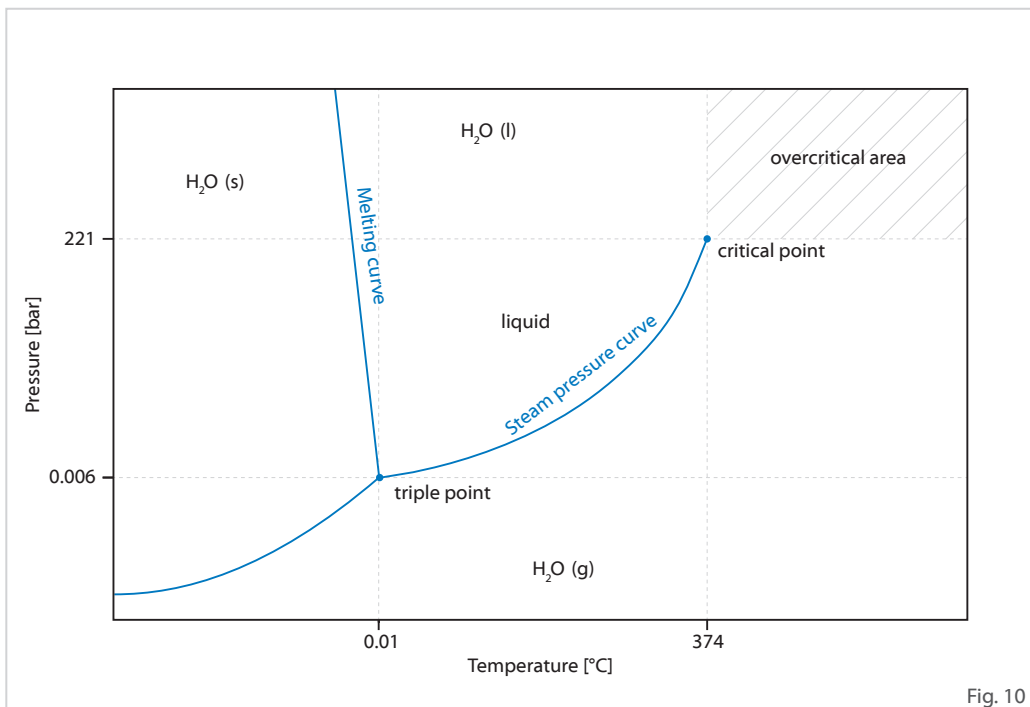

Fig. 10

In order to produce a H<sub>2</sub>O atmosphere in the furnace at temperatures above 100 °C, a water vapor generator must be used in combination with our systems. The generator evaporates water without necessarily mixing the residual water vapor with other purge gases, which allows

100% H<sub>2</sub>O atmosphere at the sample. Nevertheless it can also be diluted by adding dry gases using MFCs. The mixture is given as variable concentration (in Vol.-%, wt.% or ppm) of the water vapor in a dry carrier gas. The complete setup can be seen in Fig. 11.

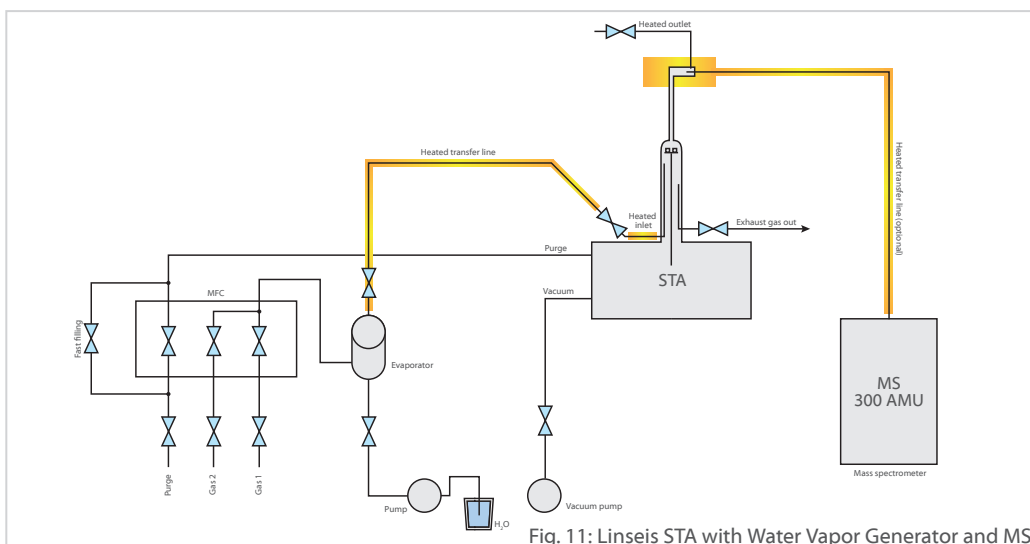
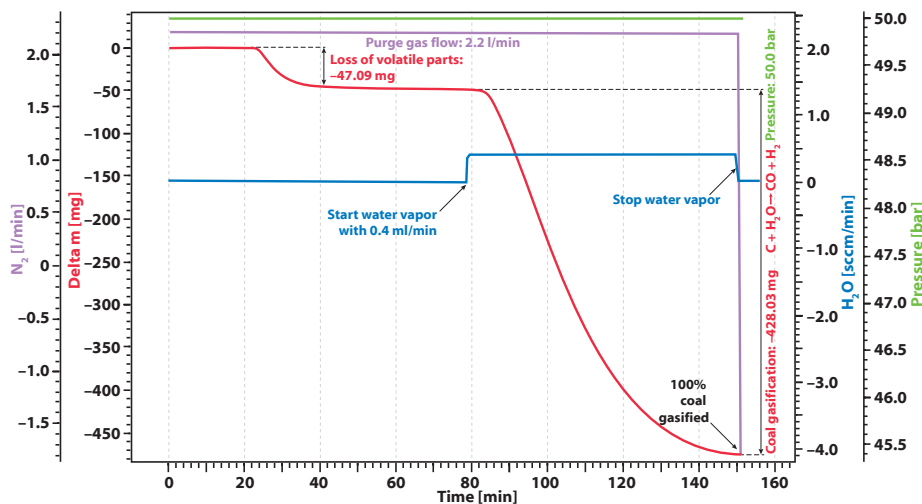

Fig. 11: Linseis STA with Water Vapor Generator and MS

The typical example for water vapor applications at elevated temperatures and pressure levels are coal and biomass gasification experiments like in the application note below in Fig 12:

Fig. 12



The given example shows a typical gasification experiment of charcoal. The coal sample was heated to an isothermal plateau under nitrogen atmosphere at 50 bar pressure (High Pressure TGA – Thermo balance). The mass signal shows the loss of volatile components between 20 and 40 min. After water vapor was added, the coal was gasified and nearly completely consumed after 150min, leading to H<sub>2</sub>, CO, CH<sub>3</sub>OH and other

useful reactive gases, as shown by the red mass loss curve. The whole process can be described like this: Carbon reacts with water vapor to a mixture of carbon monoxide and hydrogen. The obtained carbon monoxide can react with a second water molecule to carbon dioxide and additional hydrogen and finally the resulting hydrogen can form methane and other hydrocarbons out of carbon monoxide.

STA PT1600 + Water Vapor I40/WV



**LINSEIS GmbH Germany**

Vielitzerstr. 43  
95100 Selb  
Tel.: (+49) 9287 880 0  
E-mail: [info@linseis.de](mailto:info@linseis.de)

**LINSEIS Inc. USA**

109 North Gold Drive  
Robbinsville, NJ 08691  
Tel.: (+1) 609 223 2070  
E-mail: [info@linseis.de](mailto:info@linseis.de)

**LINSEIS China**

Kaige Scientific Park 2653 Hunan Road  
201315 Shanghai  
Tel.: (+86) 21 5055 0642  
Tel.: (+86) 10 6223 7812  
E-mail: [info@linseis.de](mailto:info@linseis.de)

**LINSEIS France**

2A Chemin des Eglantines  
69580 Sathonay Village  
Tel.: (+33) 6.24.72.33.31  
E-mail: [contact@ribori-instrumentation.com](mailto:contact@ribori-instrumentation.com)

**LINSEIS Poland**

ul. Dabrowskiego 1  
05-800 Pruszków  
Tel.: (+48) 692 773 795  
E-mail: [info@linseis.de](mailto:info@linseis.de)

**[www.linseis.com](http://www.linseis.com)**

**Products:** DIL, TG, STA, DSC, HDSC, DTA, TMA, MS/FTIR, In-Situ EGA, Laser Flash, Seebeck Effect, Thin Film Analyzer, Hall-Effect

**Services:** Service Lab, Calibration Service

**RMI, s.r.o.**

Pernštýnská 116  
533 41 Lázně Bohdaneč  
Tel: 466 921 885, 404  
e-mail: [sale@rmi.cz](mailto:sale@rmi.cz)  
web: [www.rmi.cz](http://www.rmi.cz)

**LINSEIS**